

Deliver to:  
 Name:  
 Street:  
 Town: Postal code:  
 E-Mail:  
 Tel: Fax:

Deliver to:  
 Name:  
 Street:  
 Town: Postal code:  
 E-Mail:  
 Tel: Fax:

Order date:  
 Purchase order:

Marked for:

Base Price
£1,997

Fax number: +44 (0)845 605 66 89  
 Email: [orders@sunmed.co.uk](mailto:orders@sunmed.co.uk)  
 Max User Weight 85Kg  
**Crash tested and Passed**

Part No. 843900001-000 PQR01

**CLIENT MEASUREMENT**

**Seat width in cm**

	22	24	26	28	30	32	34	36	38	40
Seat depth in cm	24	<input type="checkbox"/>	<input type="checkbox"/>	<input type="checkbox"/>	<input type="checkbox"/>	<input type="checkbox"/>	<input type="checkbox"/>	<input type="checkbox"/>	<input type="checkbox"/>	<input type="checkbox"/>
	26	<input type="checkbox"/>	<input type="checkbox"/>	<input type="checkbox"/>	<input type="checkbox"/>	<input type="checkbox"/>	<input type="checkbox"/>	<input type="checkbox"/>	<input type="checkbox"/>	<input type="checkbox"/>
	28	<input type="checkbox"/>	<input type="checkbox"/>	<input type="checkbox"/>	<input type="checkbox"/>	<input type="checkbox"/>	<input type="checkbox"/>	<input type="checkbox"/>	<input type="checkbox"/>	<input type="checkbox"/>
	30	<input type="checkbox"/>	<input type="checkbox"/>	<input type="checkbox"/>	<input type="checkbox"/>	<input type="checkbox"/>	<input type="checkbox"/>	<input type="checkbox"/>	<input type="checkbox"/>	<input type="checkbox"/>
	30	<input type="checkbox"/>	<input type="checkbox"/>	<input type="checkbox"/>	<input type="checkbox"/>	<input type="checkbox"/>	<input type="checkbox"/>	<input type="checkbox"/>	<input type="checkbox"/>	<input type="checkbox"/>
	32	<input type="checkbox"/>	<input type="checkbox"/>	<input type="checkbox"/>	<input type="checkbox"/>	<input type="checkbox"/>	<input type="checkbox"/>	<input type="checkbox"/>	<input type="checkbox"/>	<input type="checkbox"/>
	34	<input type="checkbox"/>	<input type="checkbox"/>	<input type="checkbox"/>	<input type="checkbox"/>	<input type="checkbox"/>	<input type="checkbox"/>	<input type="checkbox"/>	<input type="checkbox"/>	<input type="checkbox"/>
	36	<input type="checkbox"/>	<input type="checkbox"/>	<input type="checkbox"/>	<input type="checkbox"/>	<input type="checkbox"/>	<input type="checkbox"/>	<input type="checkbox"/>	<input type="checkbox"/>	<input type="checkbox"/>
	38	<input type="checkbox"/>	<input type="checkbox"/>	<input type="checkbox"/>	<input type="checkbox"/>	<input type="checkbox"/>	<input type="checkbox"/>	<input type="checkbox"/>	<input type="checkbox"/>	<input type="checkbox"/>
	40	<input type="checkbox"/>	<input type="checkbox"/>	<input type="checkbox"/>	<input type="checkbox"/>	<input type="checkbox"/>	<input type="checkbox"/>	<input type="checkbox"/>	<input type="checkbox"/>	<input type="checkbox"/>

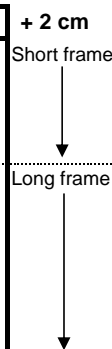

Your rear seat height can only be between 0 cm and 12 cm below your front seat height:  
 i.e. rear seat height CANNOT be above front seat height  
 i.e. rear seat height CANNOT be more than 12 cm below front seat height  
 - More info, see first back page  
 4" & 5" solid, 4" & 5" soft roll and 5" & 6" soft solid are only available with a 45 mm fork

+ 4 cm Depth growth only available on long frame Straight frame starting at 26cm

**Front seat height in cm**

	Fork (length x width)	37	38	39	40	41	42	43	44	45	46	47	48	50
4"	111 mm x 45 mm	<input type="checkbox"/>	<input type="checkbox"/>	<input type="checkbox"/>	<input type="checkbox"/>									
	123 mm x 45 mm (3) (5)			<input type="checkbox"/>	<input type="checkbox"/>	<input type="checkbox"/>	<input type="checkbox"/>							
	111 mm x 32 mm	<input type="checkbox"/>	<input type="checkbox"/>	<input type="checkbox"/>	<input type="checkbox"/>									
	138 mm x 45 mm (1)				<input type="checkbox"/>	<input type="checkbox"/>	<input type="checkbox"/>	<input type="checkbox"/>						
	174 mm x 45 mm (1) (2)							<input type="checkbox"/>	<input type="checkbox"/>	<input type="checkbox"/>	<input type="checkbox"/>	<input type="checkbox"/>	<input type="checkbox"/>	<input type="checkbox"/>
5"	111 mm x 45 mm				<input type="checkbox"/>	<input type="checkbox"/>	<input type="checkbox"/>							
	123 mm x 45 mm (3) (5)				<input type="checkbox"/>	<input type="checkbox"/>	<input type="checkbox"/>		<input type="checkbox"/>					
	111 mm x 32 mm				<input type="checkbox"/>	<input type="checkbox"/>	<input type="checkbox"/>							
	138 mm x 45 mm (1)						<input type="checkbox"/>	<input type="checkbox"/>	<input type="checkbox"/>	<input type="checkbox"/>				
	174 mm x 45 mm (1) (2)								<input type="checkbox"/>	<input type="checkbox"/>	<input type="checkbox"/>	<input type="checkbox"/>	<input type="checkbox"/>	<input type="checkbox"/>
6"	111 mm x 45 mm						<input type="checkbox"/>	<input type="checkbox"/>						
	123 mm x 45 mm (3) (5)						<input type="checkbox"/>	<input type="checkbox"/>		<input type="checkbox"/>				
	138 mm x 45 mm (1)						<input type="checkbox"/>	<input type="checkbox"/>		<input type="checkbox"/>	<input type="checkbox"/>			
	174 mm x 45 mm (1) (2)								<input type="checkbox"/>	<input type="checkbox"/>	<input type="checkbox"/>	<input type="checkbox"/>	<input type="checkbox"/>	<input type="checkbox"/>

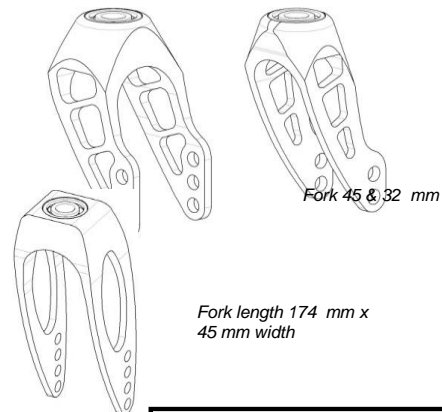

	Wheels	32	33	34	35	36	37	38	39	40	41	42	43	44	45	46	47
Rear wheel	20" (4)	<input type="checkbox"/>	<input type="checkbox"/>	<input type="checkbox"/>	<input type="checkbox"/>												
	22"				<input type="checkbox"/>	<input type="checkbox"/>	<input type="checkbox"/>	<input type="checkbox"/>		<input type="checkbox"/>	<input type="checkbox"/>	<input type="checkbox"/>	<input type="checkbox"/>	<input type="checkbox"/>	<input type="checkbox"/>	<input type="checkbox"/>	<input type="checkbox"/>
	24"									<input type="checkbox"/>	<input type="checkbox"/>	<input type="checkbox"/>	<input type="checkbox"/>	<input type="checkbox"/>	<input type="checkbox"/>	<input type="checkbox"/>	<input type="checkbox"/>

- Please note the procedure of the measurement is from the back  
 - All measurements are in cm and without a cushion

(1) Aluminium rim only (2) only grey available (3) fork compatible with additional drive (4) only Proton wheels/Right Run/Steel Handrim  
 (5) Not available with Carbotexture Fork

										£	
<b>SEAT UPHOLSTERY</b>											
<b>Seat sling</b>											
YNG020101	<input type="radio"/>	1 Utility bag								(Std default option)	
YNG020102	<input type="checkbox"/>	With two utility bags								(only from SW 34 cm)	54
YNG020103	<input type="checkbox"/>	One utility bag and one catheter bag								(only from SW 34 cm)	84
YNG020104	<input type="radio"/>	Without seat sling									
<b>For JAY Seating, see JAY order form</b>											
<b>Seat cushion with cover, black</b>											
a) Foam composite		Thickness:	YNG020201	<input type="checkbox"/>	3cm	YNG020203	<input type="checkbox"/>	5cm	(medium)	64	
b) Latex		Thickness:	YNG020202	<input type="checkbox"/>	5cm	YNG020204	<input type="checkbox"/>	8cm	(very soft)	64	
<b>Seat cushion with water resistant / breathable cover</b>											
a) Foam composite		Thickness:	YNG020205	<input type="checkbox"/>	3cm	YNG020207	<input type="checkbox"/>	5cm	(medium)	122	
b) Latex		Thickness:	YNG020206	<input type="checkbox"/>	5cm	YNG020208	<input type="checkbox"/>	8cm	(very soft)	122	
YNG020302	<input type="checkbox"/>	Spare cushion cover with zipper									37
<b>Seat accessories</b>											
YNG020301	<input type="checkbox"/>	Positioning belt with lock									42
YNG020303	<input type="checkbox"/>	JAY Fit belt 90° attachment				(attached to the seat rail)	(starts with SW 26; use with cushion only)				59
YNG020304	<input type="checkbox"/>	JAY Fit belt 45° attachment				(attached to the seat rail)	(starts with SW 26; use with cushion only)				
<b>BACKREST</b>											
<b>Backrest (range)</b>		<b>22.5 - 27.5</b>	<b>27.5 - 32.5</b>	<b>32.5 - 37.5</b>	<b>37.5 - 42.5</b>						
<b>Back height set at (cm)</b>		<input type="radio"/> 22.5	<input type="radio"/> 27.5	<input type="radio"/> 32.5	<input type="radio"/> 37.5						
		<input type="radio"/> 25	<input type="radio"/> 30	<input type="radio"/> 35	<input type="radio"/> 40						
		<input type="radio"/> 27.5	<input type="radio"/> 32.5	<input type="radio"/> 37.5	<input type="radio"/> 42.5						
<b>Backrest frame</b>											
YNG030101	<input type="radio"/>	Standard: Non angle adjustable (90°), non folding backrest									
YNG030102	<input type="checkbox"/>	Angle adjustable								(Only in combination with side guard YNG040202)	185
		<input type="checkbox"/>	87°	<input type="checkbox"/>	90°	<input type="checkbox"/>	95°	<input type="checkbox"/>	100°	<input type="checkbox"/>	105°
		<input type="checkbox"/>	Built-4-Me Option: Reclining back						(For seat depth 30 cm and above)	586	
		Infinite back recline from -3° to +20°; price includes side guard, no fender available (2)								(additional 10 day lead time)	
<b>Push handles</b>											
YNG030201	<input type="radio"/>	Without push handles								(not in combination with half folding back)	
YNG030203	<input type="radio"/>	Long									
YNG030204	<input type="checkbox"/>	123 mm x 45 mm (3) (5)								(only up from BH 32,5 cm)	133
YNG030205	<input type="checkbox"/>	Height-adjustable push handles								(only up from BH 30 cm)	185
YNG030206	<input type="checkbox"/>	Height-adjustable push handles side angled								(not in combination with drum brakes)	216
YNG030207	<input type="checkbox"/>	JAY Hardware with height adj. push handles								(only up from BH 30 cm)	178
<b>123 mm x 45 mm (3) (5)</b>											
YNG030316	<input type="radio"/>	EXO Backrest sling, synthetic fibre, padded, adjustable, 1 accessory bag, black (Evo Exo Version)									
		Colour, binding tape:	<input type="radio"/> Black	<input type="radio"/> Orange	<input type="radio"/> Silver	<input type="radio"/> Red	<input type="radio"/> Blue				
YNG030317	<input type="checkbox"/>	EXO PRO Backrest, synthetic fibre, padded, adj., breathable spacer fabric, 1 accessory bag, black (Evo Exo Version)									147
		Colour, binding tape:	<input type="radio"/> Black	<input type="radio"/> Orange	<input type="radio"/> Silver	<input type="radio"/> Red	<input type="radio"/> Blue				
YNG030305	<input type="radio"/>	123 mm x 45 mm (3) (5)									
<b>Headrest</b>											
YNG030401	<input type="checkbox"/>	Medium	YNG030402	<input type="checkbox"/>	Large						204
YNG030403	<input type="checkbox"/>	Stabiliser bar									146

(1): starting with SW 32; reduces the seat depth by approx 1cm because of the padding

(2): not in combination with Safari wheel lock; Seat depth enlargement (5 cm); Standard backrest upholstery

		£
<b>ARMREST AND SIDE GUARDS</b>		
<b>Armrest</b>		
YNG040101	<input type="checkbox"/> Armrest height adjustable, short, screw-on <span style="float: right;"><i>(only with YNG040201, YNG040202 and YNG040211)</i></span>	91
<b>Side guards</b>		
YNG040201	<input type="checkbox"/> Straight side guard aluminium with cloth protection	144
YNG040202	<input type="checkbox"/> Aluminium side guard for angle adjustable back at fixed angles with cloth protection	166
YNG040203	<input type="checkbox"/> Lightweight carbonfibre look side guard with integrated clothing guard <b>(1)</b>	233
YNG040211	<input type="checkbox"/> Straight side guard aluminium with fender (Pair) - Tool height adj armrest possible	253
YNG040212	<input type="checkbox"/> Straight side guard aluminium with fender (Pair) for Safari wheel lock	253
YNG040205	<input type="checkbox"/> Plastic side guards detachable (Quickie style) <span style="float: right;"><i>(Quickie style)</i></span>	171
<b>Side guards options and accessories</b>		
YNG040210	<input type="checkbox"/> Mud Guard <span style="float: right;"><i>(only with YNG040201 and YNG040202)</i></span>	
YNG040204	<input type="checkbox"/> Fender, composite, screw-on, back <span style="float: right;"><i>(only with YNG040201 and YNG040202)</i></span>	70
YNG040206	<input type="checkbox"/> Height adjustable tray table, slide-on for SW 22-36cm (not 38 & 40cm)	145
	Therapy table flip-down for SW 26-40cm	
	Attachment: <input type="checkbox"/> YNG040207 right-hand <input type="checkbox"/> YNG040208 left-hand	203
<b>LEGREST &amp; FOOTPLATES</b>		
	Platform footrest, angle adjustable (only in position 3 - page 6/9) <span style="float: right;"><i>(LLL 30 - 45cm)</i></span>	
YNG050102	<input type="radio"/> Composite board <span style="float: right;"><i>(Abduction frame SW 26 - 40; Std 30 - 40)</i></span> <span style="float: right;"><i>(depth adjustable)</i></span>	
YNG050103	<input type="checkbox"/> Carbon board <span style="float: right;"><i>(depth adjustable)</i></span>	315
YNG050115	<input type="checkbox"/> Foot positioning plate	70
YNG050106	<input type="radio"/> Platform footrest "Youngster 3" <span style="float: right;"><i>(SW 38 &amp; 40 with abduction is supplied w aluminium board)</i></span>	
YNG050107	<input type="checkbox"/> Locking system for platform footrest	55
YNG050108	<input type="checkbox"/> Swing Away mechanism <span style="float: right;"><i>(not with Platform footrest, angle adjustable)</i></span>	143
YNG050111	<input type="radio"/> Divided platform "Youngster 3" - composite <span style="float: right;"><i>(not in SW 22cm)</i></span>	
	Locking system for divided footrest	
YNG050112	<input type="checkbox"/> Right attachment	55
YNG050113	<input type="checkbox"/> Left attachment	55
YNG050114	<input type="checkbox"/> Lock for divided footrest (Right and left)	108
YNG050101	<input type="radio"/> Divided platform footrest Alu "Youngster3" <span style="float: right;"><i>(starts w abdu frame SW 26, Std SW 30cm)</i></span>	
	Clamp for platform footrest "Youngster3" <span style="float: right;"><i>(not with Platform footrest, angle adjustable)</i></span>	
	<input type="radio"/> YNG050116 Short (90mm) <input type="radio"/> YNG050117 Long (121mm) <span style="float: right;"><i>(Std if nothing else selected)</i></span>	
<b>Lower leg length (LLL)</b> <span style="float: right;"><i>(Attention: LLL has to be 2,5 cm lower than seat height front)</i></span>		
<input type="radio"/> 17	<input type="radio"/> 18	<input type="radio"/> 19
<input type="radio"/> 20	<input type="radio"/> 21	<input type="radio"/> 22
<input type="radio"/> 23	<input type="radio"/> 24	<input type="radio"/> 25
<input type="radio"/> 26	<input type="radio"/> 27	<input type="radio"/> 28
<input type="radio"/> 29	<input type="radio"/> 30	<input type="radio"/> 31
<input type="radio"/> 32	<input type="radio"/> 33	<input type="radio"/> 34
<input type="radio"/> 35	<input type="radio"/> 36	<input type="radio"/> 37
<input type="radio"/> 38	<input type="radio"/> 39	<input type="radio"/> 40
<input type="radio"/> 41	<input type="radio"/> 42	<input type="radio"/> 43
<input type="radio"/> 44	<b>All measurements are in cm</b>	
<b>FRAME</b> <span style="float: right;"><i>(with smart and nice folding fixation and frame protection for the rear frame end and the axle plate)</i></span>		
YNG010101	<input type="radio"/> 1 Standard folding frame (straight) <span style="float: right;"><i>(from SW 26 - 40 cm)</i></span>	
YNG010102	<input type="radio"/> Abduction folding frame <span style="float: right;"><i>(from SW 22 - 40 cm)</i></span>	
<b>Seat depth enlargement (5cm)</b> <span style="float: right;"><i>(all measurements are in cm)</i></span>		
YNG010201	<input type="checkbox"/> Seat depth enlargement (50 mm) <b>(2) (3) (4)</b> 1 Increases seat depth by 50 mm allowing better COG adjustment when used in combination with seat shells <span style="float: right;"><i>(only in combination with adjustable upholstery)</i></span>	275

(1): not with combination cloth protection, armrest & plastic sideguard

(2): not with Safari wheel-lock

(3): only with YNG040201 & YNG040202

(4): not with mud guard

			£
<b>Frame accessories</b>			<i>(choose either tip assist or anti-tip tubes, not both)</i>
<b>Tip assist (step tube)</b>			
YNG010301	<input type="checkbox"/> Left	YNG010302 <input type="checkbox"/> Right	33
YNG010305	<input type="checkbox"/> Pair		67
YNG010303	<input type="checkbox"/> Crutch holder with Velcro	<i>(only in combination with tip assist)</i>	71
<b>Anti-tip tubes, swing-away</b>			
YNG010306	<input type="checkbox"/> Left	YNG010307 <input type="checkbox"/> Right	93
YNG010308	<input type="checkbox"/> Pair		185
<b>FORK</b>			
<i>(compare with your choice on the first page)</i>			
YNG080101	<input checked="" type="radio"/> Fork Carbotecture® (4)		
YNG090093	<input type="checkbox"/> Fork for power add ons, 123x45 mm	<i>(only in black)</i>	67
<b>CASTORS</b>			
<i>(compare with your choice on the first page)</i>			
<b>Standard</b>			
YNG080201	<input type="radio"/> Solid	<i>(for 45 mm fork version only)</i>	<i>(only for 4" &amp; 5")</i>
YNG080202	<input type="radio"/> Soft solid	<i>(for 45 mm fork version only, not available with 111x45)</i>	<i>(only for 5" &amp; 6")</i>
<b>Light ups</b>			
YNG080203	<input type="checkbox"/> Solid Light Ups	<i>(not available for 6")</i>	70
<b>Castor with aluminium rim</b>			
YNG080204	<input type="checkbox"/> Solid Aluminium	<i>(only for 4" and 5")</i>	81
YNG080205	<input type="checkbox"/> Soft roll	<i>(for 45 mm fork version only)</i>	<i>(only for 4" and 5")</i>
<b>REAR WHEELS</b>			
YNG070101	<input type="radio"/> Straight spoked	<i>(only 22")</i>	
YNG070102	<input type="radio"/> Cross spoked	<i>(pair)</i>	<i>(only 22" &amp; 24")</i>
YNG070103	<input type="radio"/> Design wheel	<i>(pair)</i>	<i>(only 24")</i>
YNG070104	<input type="radio"/> Lightweight wheel	<b>(2)</b>	<i>(pair)</i>
YNG070105	<input type="checkbox"/> Proton wheel (super light weight)	<b>(2)</b>	<i>(pair)</i>
YNG070111	<input type="checkbox"/> Drum brake wheels for attendant person	<i>(pair)</i>	<i>(only 22" &amp; 24")</i>
YNG070106	<input type="checkbox"/> Mountain Bike wheel	<i>(only with 24", mountain bike tyres &amp; aluminium rim, black coated)</i>	335
YNG070107	<input type="checkbox"/> Additional mountain bike wheel pair	<i>(only with 24" &amp; mountain bike tyres )</i>	453
One-arm drive with quick-release axle, one-arm brake not included <b>(3)</b>			
YNG070108	<input type="checkbox"/> Left	YNG070109 <input type="checkbox"/> Right	1082
<b>TYRES</b>			
<i>(choose only one tyre type)</i>			
YNG070201	<input type="radio"/> Right Run		
YNG070202	<input type="radio"/> Solid tyres	<b>(1)</b>	<i>(only 22" &amp; 24", not available with Safari wheel locks)</i>
YNG070203	<input type="radio"/> Schwalbe One (Slight puncture resistance)		<i>(only 24")</i>
YNG070204	<input type="checkbox"/> 24" Two grip "down town"		<i>(only 24")</i>
YNG070205	<input type="checkbox"/> Marathon plus evolution	<i>(puncture proof)</i>	<i>(only 24")</i>
<b>HANDRIM</b>			
<i>Not available for Mountain Bike or Spinergy wheels</i>			
YNG070301	<input type="radio"/> Aluminium silver anodized	<b>(2)</b>	
YNG070302	<input type="radio"/> Aluminium silver powdercoated	<b>(2)</b>	
YNG070303	<input type="checkbox"/> Coloured aluminium pushrim. colour code: .....	<i>(see page 5)</i>	60
YNG070304	<input type="radio"/> Stainless steel		<i>(only 22" &amp; 24")</i>
YNG070305	<input type="checkbox"/> Titanium		<i>(only 22" &amp; 24")</i>
YNG070306	<input type="checkbox"/> Titanium clear powdercoated		<i>(only 22" &amp; 24")</i>
YNG070307	<input type="checkbox"/> Supergrip	<i>(only 22" &amp; 24" and not available with lightweight wheels)</i>	222
YNG070308	<input type="checkbox"/> Maxgripp	<i>(only 22" &amp; 24")</i>	222
Hand rim mounting	YNG070401 Standard = 17mm	YNG070402 <input type="radio"/> Wide = 27mm	
	YNG070403 <input type="radio"/> Close = 7mm		<i>(only with 24" stainless steel)</i>
YNG070309	<input type="checkbox"/> Handrim cover		<i>(only 22" &amp; 24")</i>
<b>WHEEL CAMBER</b>			
<i>(choose only one option)</i>			
YNG070501	<input type="radio"/> 0°	YNG070504 <input type="radio"/> 3°	
YNG070502	<input type="radio"/> 1°	YNG070505 <input type="radio"/> 4°	
Not available with Carbotecture Fork			
<b>Quick release axle</b>			
YNG070506	<input type="radio"/> Std		
YNG070507	<input type="checkbox"/> Quad		105

- (1): not with Lightweight and Proton (2): not with handrim mounting wide for Lightweight and Proton wheels  
(3): no colour coat, no camber adjustment, no drum brakes. Only with cross-spoked rear wheel available min. SW = 28  
(4): Not available with 123 x 45 Fork Size

										£				
<b>SPOKE GUARDS</b>										(only available in 22 & 24")				
YNG070601	<input type="checkbox"/>	Transparent									122			
YNG070602	<input type="checkbox"/>	Rotation	YNG070613	<input type="checkbox"/>	Graphic	YNG070624	<input type="checkbox"/>	Bibbo						
YNG070603	<input type="checkbox"/>	Fantasy	YNG070614	<input type="checkbox"/>	Galactica	YNG070625	<input type="checkbox"/>	Cheese						
YNG070604	<input type="checkbox"/>	Princess	YNG070615	<input type="checkbox"/>	Dancing Bear	YNG070626	<input type="checkbox"/>	Jungle Fever						
YNG070605	<input type="checkbox"/>	Happy Lions	YNG070616	<input type="checkbox"/>	Water world	YNG070627	<input type="checkbox"/>	Randolf						
YNG070606	<input type="checkbox"/>	Monkeys	YNG070617	<input type="checkbox"/>	Pirates	YNG070628	<input type="checkbox"/>	Feather						
YNG070607	<input type="checkbox"/>	Oriental	YNG070618	<input type="checkbox"/>	Racing	YNG070629	<input type="checkbox"/>	Dirt Race						
YNG070608	<input type="checkbox"/>	Superhero	YNG070619	<input type="checkbox"/>	Graffiti	YNG070630	<input type="checkbox"/>	Chrome wheel						
YNG070609	<input type="checkbox"/>	Hot Wheels	YNG070620	<input type="checkbox"/>	Basketball	YNG070631	<input type="checkbox"/>	Basketball 2						
YNG070610	<input type="checkbox"/>	Pool	YNG070621	<input type="checkbox"/>	Flying water	YNG070632	<input type="checkbox"/>	Space						
YNG070611	<input type="checkbox"/>	Silk	YNG070622	<input type="checkbox"/>	Abstract	YNG070633	<input type="checkbox"/>	Creative						
YNG070612	<input type="checkbox"/>	Tiger	YNG070623	<input type="checkbox"/>	Zebra	(see Spoke Guard brochure)								
<b>WHEEL LOCKS</b>										(choose only one option)				
YNG060101	<input type="radio"/>	Standard wheel lock												
Knee lever wheel lock										57				
YNG060104	<input type="checkbox"/>	angled to the inside	YNG060102	<input type="checkbox"/>	angled to the outside									
YNG060105	<input type="radio"/>	Safari wheel lock (Wheel lock integrated into side guard)												
YNG060106	<input type="checkbox"/>	Attendant wheel lock with Safari wheel lock									(incl. YNG060105)	138		
YNG060107	<input type="checkbox"/>	Drum brake (for care person, quick-release axle, not available with attendant wheel lock)									(only 22" & 24")	405		
<b>Wheel lock accessories</b>														
YNG060201	<input type="checkbox"/>	Extension for knee lever wheel lock, slip-on, swing-away									(only on knee lever wheel lock)	42		
<b>ACCESSORIES</b>														
● Tool kit														
YNG090101	<input type="checkbox"/>	High pressure pump									80			
YNG090102	<input type="checkbox"/>	Air pump									11			
YNG090103	<input type="checkbox"/>	Back pack									59			
YNG090104	<input type="checkbox"/>	Net back bag									26			
YNG090105	<input type="checkbox"/>	Impact guard									62			
YNG090106	<input type="checkbox"/>	Bag caddy									(not with high mount platform footplates)	59		
YNG090107	<input type="checkbox"/>	Mobile phone bag									18			
<b>COLOUR</b>														
			Handrim £60	Hub/rim £171			Handrim £60	Hub/rim £171						
01 White RAL 9010	12	<input type="radio"/>	YNG090201	<input type="checkbox"/>	YNG090301	<input type="checkbox"/>	YNG090401	27 Graphite Metallic	<input type="radio"/>	YNG090224	<input type="checkbox"/>	YNG090324	<input type="checkbox"/>	YNG090424
02 Brilliant Silver		<input type="radio"/>	YNG090202	<input type="checkbox"/>	YNG090302	<input type="checkbox"/>	YNG090402	28 Platinum Metallic	<input type="radio"/>	YNG090225	<input type="checkbox"/>	YNG090325	<input type="checkbox"/>	YNG090425
03 Matt Silver		<input type="radio"/>	YNG090203	<input type="checkbox"/>	YNG090303	<input type="checkbox"/>	YNG090403	29 Black	<input type="radio"/>	YNG090226	<input type="checkbox"/>	YNG090326	<input type="checkbox"/>	YNG090426
04 Silver		<input type="radio"/>	YNG090204	<input type="checkbox"/>	YNG090304	<input type="checkbox"/>	YNG090404	31 Matt black	<input type="radio"/>	YNG090228	<input type="checkbox"/>	YNG090328	<input type="checkbox"/>	YNG090428
06 Sun Yellow		<input type="radio"/>	YNG090205	<input type="checkbox"/>	YNG090305	<input type="checkbox"/>	YNG090405	32 Signal white	<input type="radio"/>	YNG090229	<input type="checkbox"/>	YNG090329	<input type="checkbox"/>	YNG090429
07 Brilliant Lime	12	<input type="radio"/>	YNG090206	<input type="checkbox"/>	YNG090306	<input type="checkbox"/>	YNG090406	s Pink	<input type="radio"/>	YNG090230	<input type="checkbox"/>	YNG090330	<input type="checkbox"/>	YNG090430
08 Matt Lime		<input type="radio"/>	YNG090207	<input type="checkbox"/>	YNG090307	<input type="checkbox"/>	YNG090407	34 Dark Chocolate Metallic	<input type="radio"/>	YNG090233	<input type="checkbox"/>	YNG090333	<input type="checkbox"/>	YNG090433
14 Blue		<input type="radio"/>	YNG090212	<input type="checkbox"/>	YNG090312	<input type="checkbox"/>	YNG090412	35 Sky Blue	<input type="radio"/>	YNG100127	<input type="checkbox"/>	YNG100227	<input type="checkbox"/>	YNG100327
15 Brilliant Marine		<input type="radio"/>	YNG090213	<input type="checkbox"/>	YNG090313	<input type="checkbox"/>	YNG090413	36 Cyan Metallic	<input type="radio"/>	YNG100128	<input type="checkbox"/>	YNG100228	<input type="checkbox"/>	YNG100328
16 Matt Marine		<input type="radio"/>	YNG090214	<input type="checkbox"/>	YNG090314	<input type="checkbox"/>	YNG090414	37 Mars Red	<input type="radio"/>	YNG100129	<input type="checkbox"/>	YNG100229	<input type="checkbox"/>	YNG100329
19 Brilliant Purple	12	<input type="radio"/>	YNG090216	<input type="checkbox"/>	YNG090316	<input type="checkbox"/>	YNG090416	39 Cappuccino	<input type="radio"/>	YNG100131	<input type="checkbox"/>	YNG100231	<input type="checkbox"/>	YNG100331
20 Matt Purple		<input type="radio"/>	YNG090217	<input type="checkbox"/>	YNG090317	<input type="checkbox"/>	YNG090417	40 Kiwi	<input type="radio"/>	YNG100132	<input type="checkbox"/>	YNG100232	<input type="checkbox"/>	YNG100332
21 Red Ruby		<input type="radio"/>	YNG090218	<input type="checkbox"/>	YNG090318	<input type="checkbox"/>	YNG090418	41 Flamingo Glitter	<input type="radio"/>	YNG100133	<input type="checkbox"/>	YNG100233	<input type="checkbox"/>	YNG100333
22 Brilliant Red		<input type="radio"/>	YNG090219	<input type="checkbox"/>	YNG090319	<input type="checkbox"/>	YNG090419	42 Matt Anthracite	<input type="radio"/>	YNG100134	<input type="checkbox"/>	YNG100234	<input type="checkbox"/>	YNG100334
23 Matt Red		<input type="radio"/>	YNG090220	<input type="checkbox"/>	YNG090320	<input type="checkbox"/>	YNG090420	43 Azure Blue	<input type="radio"/>	YNG100135	<input type="checkbox"/>	YNG100235	<input type="checkbox"/>	YNG100335
24 Tutti Fruitti Orange		<input type="radio"/>	YNG090221	<input type="checkbox"/>	YNG090321	<input type="checkbox"/>	YNG090421							
26 Silver texture		<input type="radio"/>	YNG090223	<input type="checkbox"/>	YNG090323	<input type="checkbox"/>	YNG090423							
										<b>Anodised colour package for fork and axle plate</b>				
										YNG090507 Silver Matt <input type="radio"/> YNG090509 Black <input type="radio"/>				
<b>Zippie Youngster 3 - Base Price</b>										<b>£1,997</b>				

Option price	£
<b>Total Price</b>	£

**Please follow measuring method:**

The following method is recommended on the basis of extensive practical experience.  
Deviations are possible in individual instances

**Seat width:**

**a) For the user:**

Allow space of side guard to pass vertically between hip and side guard on each side (approx. 1 - 2 cm altogether).

**b) On the wheelchair:**

From outside frame tube to outside frame tube

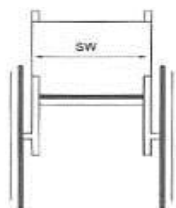

**Seat depth:**

**a) For the user:**

When sitting upright: leave space for 2-3 fingers between front edge of seat upholstery and back of knee (approx. 3-6 cm). Care must be taken with adjustable upholstery.

**b) On the wheelchair:**

From back tube to front of seat upholstery.

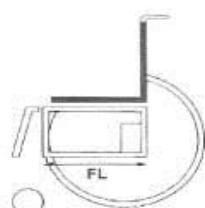

**Back height:**

**a) For the user:**

Measured from the seat, including cushion, to **no more** than one finger (1 - 2 cm) below the lower shoulder blade.

**Important!** The back height depends on the degree of disability.

**b) On the wheelchair:**

From seat tube to upper edge of backrest upholstery.

**Note:** The user's ability to sit upright has a major influence on the back height and it can therefore differ considerably.

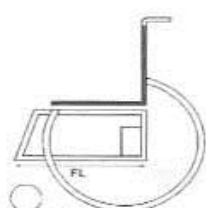

**Lower leg length:**

**a) For the user:**

With legs angled at right angles, from back of knee to bottom of shoe sole.

**b) On the wheelchair:**

From front of seat to top of footrest.

**Remember:** to include the cushion height

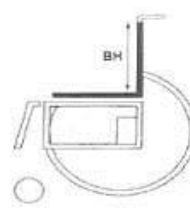

**Overall width:**

Overall width: 70 cm  
Max overall height 97 cm  
Max overall length 107 cm

**Overall width with 24"**

For 0° camber: SW+20  
For camber: each degree is adding approx 1 cm  
With drum brake +2 cm

**Weights:**

Minimum weight:  
approx 8.5 kg

**Folded size:**

with rear wheels approx. 30 cm  
without rear wheels approx. 24 cm  
123 mm x 45 mm **(3) (5)**

**NOTES:**

Max seat height difference rear to front is 12 cm.

No negative seat angle is possible

Manufacturing tolerances of +/- 1 cm

123 mm x 45 mm **(3) (5)**

123 mm x 45 mm **(3) (5)**

- Aluminium frame with integrated footrest
- Seat Depth 24 cm - 30 cm (short frame) 22" rear wheel
- Seat Depth 30 cm - 40 cm (long frame) 22" or 24" rear wheel
- Abduction frame if wanted
- Seat angle 4°
- Backrest as requested.
- Each degree of extra rear wheel camber would increase total chair width by 1 cm

- Side guard as requested
- Position of rear wheel
- 2 hole from back of the frame
- 3 position from the top of the frame
- Handrim in close position
- Camber from 0 to 4 degrees as requested
- Castors as requested
- Weight 7.7 kg without side guard + footrest

(5) Not available with Carbotexture Fork

**YOUNGSTER 3 Seat heights and lower leg length**

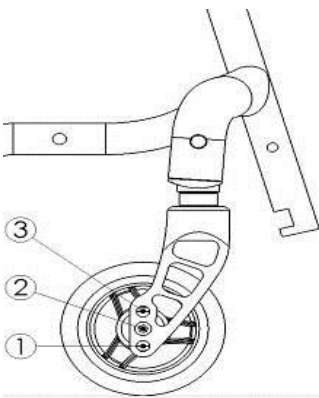
Seat height matrix - front seat height (in cm)					
	Fork Position	Caster size			
		4"	5"	6"	
	Fork (32/98 mm)	2	38	X	X
		1	40	41	X
	Fork (32/111 mm)	2	40	41	X
		1	41	42	X
	Fork (45/111 mm)	3	39	X	X
		2	40	41	X
		1	41	42	43
	Fork (45/123)	3	40	41	X
	2	41	42	43	
	1	42	44	45	
Fork (45/138 mm)	3	42	43	43	
	2	43	44	45	
	1	44	45	46	
Fork (45/174 mm)	4	X	45	46	
	3	44	46	47	
	2	46	47	48	
	1	47	48	50	

**Details:**  
 \* SH-details with 10 mm spacer between fork and frame - spacer could be mounted underneath the fork => reduced SH - 10 mm  
 \* without cushion  
 \* without seat angle (0°)  
 \* X = No Go

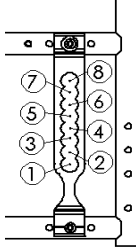
Seat height back (in cm) with rear wheels 20, 22 and 24"					
	Axle plate position	rear wheel size			
		20"	22"	24"	
		8	32	35.5	X
		7	33	37	X
		6	35	38	41
		5	X	40	42.5
		4	X	41.5	43.5
		3	X	43	44.5
		2	X	44	45.5
		1	X	45.5	47

**Details**  
 \* measurements made with 1"-tyres  
 \* without cushion 123 mm x 45 mm (3) (5)  
 \* without camber (0°)  
 \* without seat angle (0°)  
 \* X = No Go

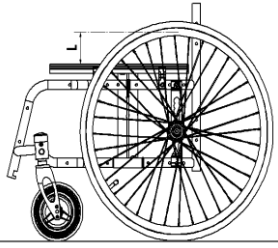
Distance between seat and handrim (outside tube)					
	Axle plate position	rear wheel size			
		20"	22"	24"	
	123 mm x 45 mm (8)	8	12.5	14	X
		7	11	13	X
		6	10	11.5	14.5
		5	X	10	13
	123 mm x 45 mm (4)	4	X	9	12
		3	X	8	10.5
		2	X	6.5	9.5
		1	X	5	8

**Details**  
 \* without cushion  
 \* without camber (0°)  
 \* X = No Go

**Y3-LLL matrix; platform footrest, angle adjustable**

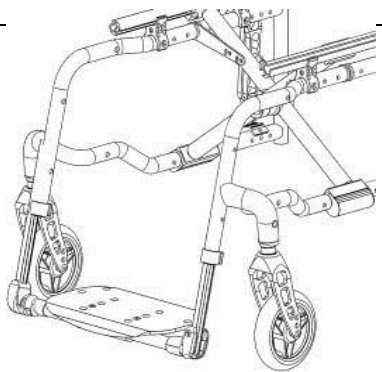
	Fork position	4"-Caster		5"-Caster		6"-Caster	
		30	34	X	X	X	X
(5) Not available with Carbotexture Fork	2	30	34			X	X
		30	34			X	X
Fork 111 mm	1	30	35	X	X	X	X
	3	30	34	X	X	X	X
	2	30	35	X	X	X	X
Fork 123 mm	1	30	36	X	X	X	X
	3	30	35	X	X	X	X
	2	30	36	X	X	X	X
Fork 138 mm	1	30	38	30	39	X	X
	3	30	36	X	X	X	X
	2	30	38	30	39	X	X
Fork 174 mm	1	30	39	30	40	X	X
	4	X	X	30	40	X	X
	3	30	40	30	41	30	34
	2	30	41	30	43	30	43
	1	30	42	30	44	30	45



**Y3-platform footrest "Youngster 3 " style**

Footplate position 1	Fork position	4"-Castor				5"-Castor				6"-Castor			
		Clamp short		Clamp long		Clamp short		Clamp long		Clamp short		Clamp long	
		min. LLL	max. LLL	min. LLL	max. LLL	min. LLL	max. LLL	min. LLL	max. LLL	min. LLL	max. LLL	min. LLL	max. LLL
Fork 98 mm	2	15	26	12	29	X	X	X	X	X	X	X	X
	1	15	26	12	29	15	26	12	29	X	X	X	X
	3	15	26	12	29	X	X	X	X	X	X	X	X
Fork 111 mm	2	15	26	12	29	15	26	12	29	X	X	X	X
	1	15	26	12	29	15	26	12	29	15	26	12	29
	3	15	26	12	29	15	26	12	29	15	26	X	X
Fork 123 mm	2	15	26	12	29	15	26	12	29	15	26	12	29
	1	15	26	12	29	15	26	12	29	15	26	12	29
	3	15	26	12	29	15	26	12	29	15	26	12	29
Fork 138 mm	2	15	26	12	29	15	26	12	29	15	26	12	29
	1	15	26	12	29	15	26	12	29	15	26	12	29
	4	X	X	X	X	15	26	12	29	15	26	12	29
Fork 174 mm	3	15	26	12	29	15	26	12	29	15	26	12	29
	2	15	26	12	29	15	26	12	29	15	26	12	29
	1	15	26	12	29	15	26	12	29	15	26	12	29

Footplate position 2	Fork position	4"-Castor				5"-Castor				6"-Castor			
		Clamp short		Clamp long		Clamp short		Clamp long		Clamp short		Clamp long	
		min. LLL	max. LLL	min. LLL	max. LLL	min. LLL	max. LLL	min. LLL	max. LLL	min. LLL	max. LLL	min. LLL	max. LLL
Fork 98 mm	2	14	24	11	26	X	X	X	X	X	X	X	X
	1	14	24	11	26	14	24	11	26	X	X	X	X
	3	14	24	11	26	X	X	X	X	X	X	X	X
Fork 111 mm	2	14	24	11	26	14	24	11	26	X	X	X	X
	1	14	24	11	26	14	24	11	26	14	24	11	26
	3	14	24	11	26	14	24	11	26	14	24	X	X
Fork 123 mm	2	14	24	11	26	14	24	11	26	14	24	11	26
	1	14	24	11	26	14	24	11	26	14	24	11	26
	3	14	24	11	26	14	24	11	26	14	24	11	26
Fork 138 mm	2	14	24	11	26	14	24	11	26	14	24	11	26
	1	14	24	11	26	14	24	11	26	14	24	11	26
	4	X	X	X	X	14	24	11	26	14	24	11	26
Fork 174 mm	3	14	24	11	26	14	24	11	26	14	24	11	26
	2	14	24	11	26	14	24	11	26	14	24	11	26
	1	14	24	11	26	14	24	11	26	14	24	11	26

123 mm x 45 mm (3) (5)

Footplate position 3	Fork position	4"-Castor				5"-Castor				6"-Castor			
		Clamp short		Clamp long		Clamp short		Clamp long		Clamp short		Clamp long	
		min. LLL	max. LLL	min. LLL	max. LLL	min. LLL	max. LLL	min. LLL	max. LLL	min. LLL	max. LLL	min. LLL	max. LLL
Fork 98 mm	2	25	35	22	35	X	X	X	X	X	X	X	X
	23 mm x 45 mm (3) (5)	25	36	22	36	25	35	22	38	X	X	X	X
	3	25	36	22	36	X	X	X	X	X	X	X	X
Fork 111 mm	2	25	37	22	37	25	35	22	38	X	X	X	X
	1	25	38	22	38	25	37	22	39	25	35	22	38
	3	25	37	22	35	25	35	22	38	X	X	X	X
Fork 123 mm	23 mm x 45 mm (3) (5)	25	38	22	36	25	37	22	40	25	35	22	38
	1	25	39	22	39	25	41	22	41	25	36	22	40
	3	25	36	22	39	25	36	22	40	25	35	22	38
Fork 138 mm	2	25	40	22	40	25	40	22	41	25	37	22	40
	1	25	41	22	42	25	41	22	42	25	39	22	42
	4	X	X	X	X	25	42	22	42	25	38	22	42
Fork 174 mm	3	25	42	22	42	25	43	22	43	25	41	22	44
	2	25	43	22	43	25	44	22	44	25	45	22	45
	1	25	44	22	44	25	46	22	46	25	47	22	47

**ARMREST AND SIDEGUARDS**

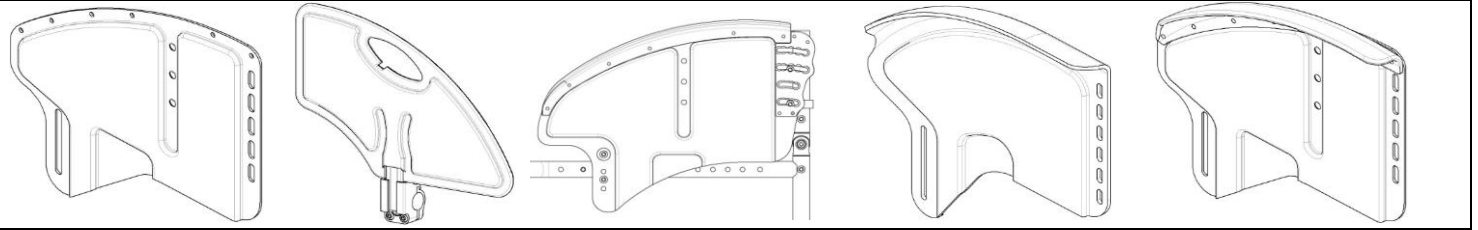

YNG040201

YNG040205

YNG040202

YNG040203

YNG040204

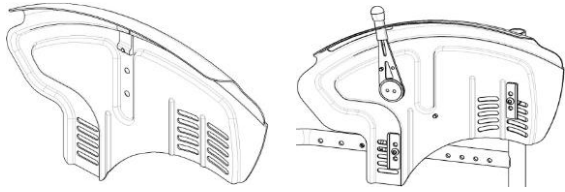

YNG040211

YNG040212

**LEGREST & FOOTPLATES**

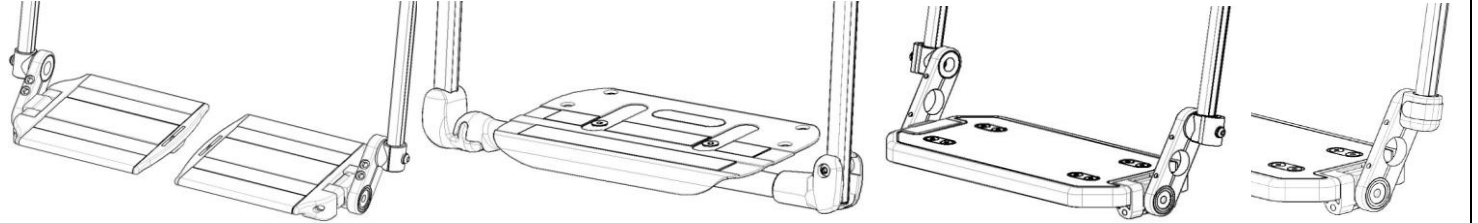

YNG050101

YNG050102 / YNG050103

YNG050106

YNG050108

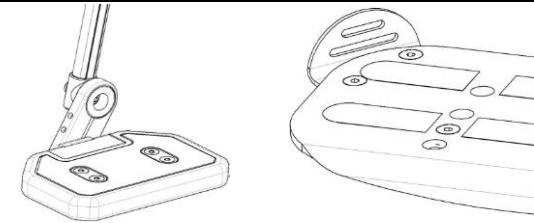

YNG050111

YNG050115

**WHEEL LOCKS**

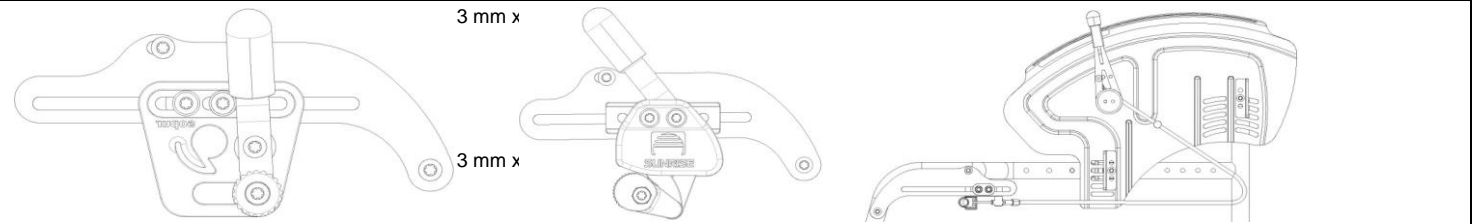

YNG060101

YNG060102

YNG060105

**FRAME 123 mm x 45 mm (3) (5)**

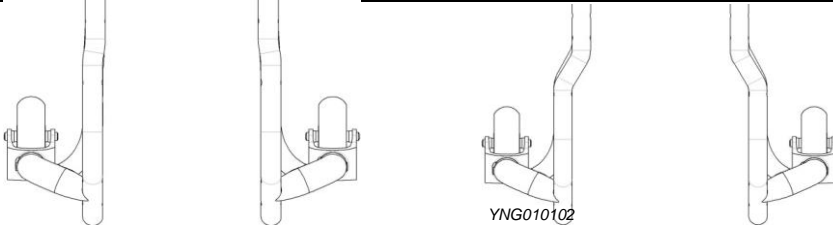

YNG010101

YNG010102  
YNG010102

**BACKREST**

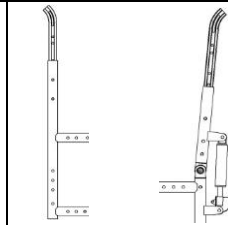

YNG030101

B4me

**Seat depth growth**

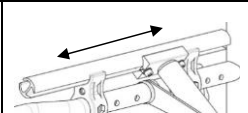

YNG010201  
YNG010201

(5) Not available with Carbotexture Fork