

MOBILITY SCOOTER



Instructions for Use

S-Series

S400 - S425 - S700



22217032: EN

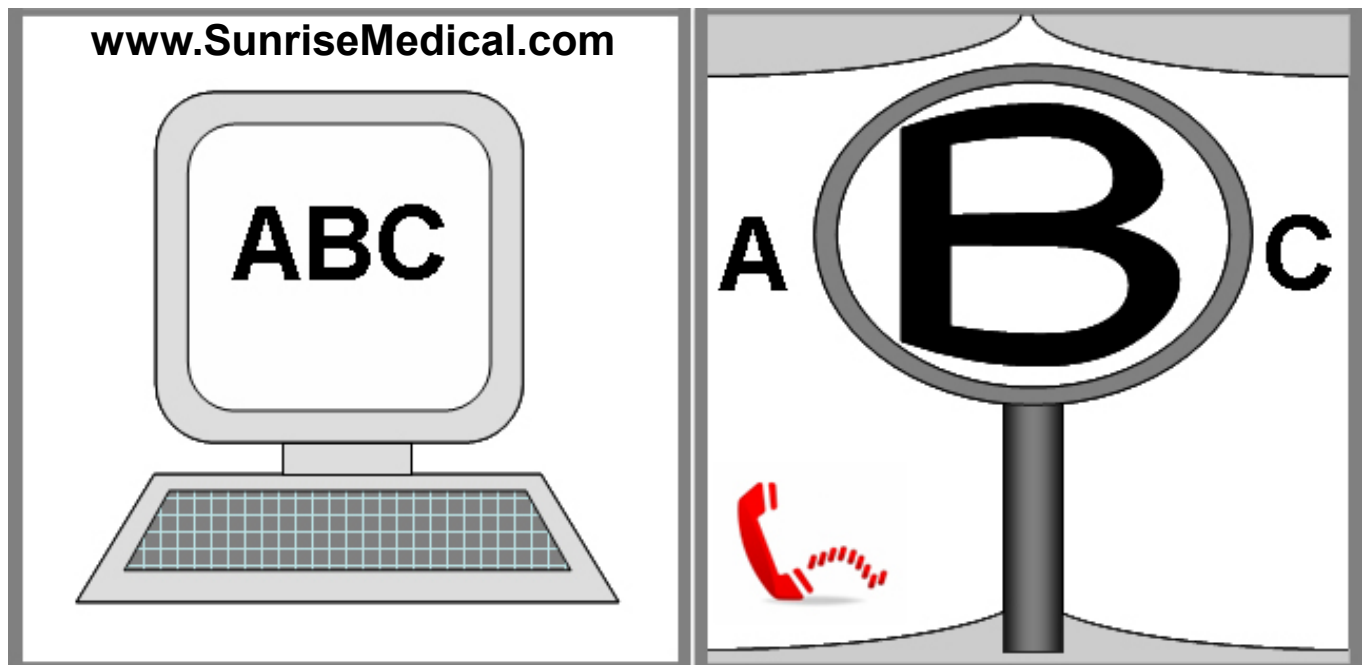

If you are visually impaired, this document can be viewed in PDF format at:  
[www.Sunrise Medical.co.uk](http://www.SunriseMedical.co.uk)

For further information on the full specification and options and accessories,  
please refer to the order form.

All information is subject to change without notification.

Please consult Sunrise Medical with any queries you may have.

 **DANGER!**

**IF YOU REQUIRE LARGE TEXT, SUNRISE MEDICAL  
STRONGLY RECOMMEND THAT YOU SEEK A CLINICAL  
EYESIGHT ASSESSMENT BEFORE USING THIS PRODUCT.**

Your scooter may sometimes display badges showing a different name to that referred to in this owner's manual. This is due to an agreement between the retailer and Sunrise Medical, allowing the retailer to rename the scooter to suit their product branding.

This does not affect your guarantee in any way.

For the purposes of official communication, this product can be positively identified by referring to the serial number label located on the seat post of the scooter, and also on a duplicate serial number label attached to this owner's manual.

## Foreword

### Dear Customer,

We are very happy that you have decided in favour of a high-quality SUNRISE MEDICAL product.

This user's manual will provide numerous tips and ideas so that your new scooter can become a trustworthy and reliable partner in your life.

We want you to be satisfied with our products and service. Sunrise Medical has been consistently working at continuously developing its products, for this reason, changes can occur in our palette of products with regard to form, technology and equipment. Consequently, no claims can be construed from the data or pictures contained in this user's manual.

The management system of SUNRISE MEDICAL is certified to ISO 9001, ISO 13485 and ISO 14001.









**As the manufacturer, SUNRISE MEDICAL, declares that the scooters conform to the 93/42/EEC, amended by 2008/47/EC guideline.**



Please contact your local, authorised SUNRISE MEDICAL dealer if you have any questions regarding the use, maintenance or safety of your scooter.

In case there is no authorised dealer in your area or you have any questions, contact Sunrise Medical either in writing or by telephone (contact addresses can also be found on the back page).

Sunrise Medical  
Thorns Road  
Brierley Hill  
West Midlands  
DY5 2LD  
England  
Phone: 0845 605 66 88  
Fax: 0845 605 66 89  
www.SunriseMedical.co.uk

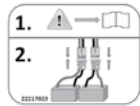
## Label Explanation / Word definitions

Word	Definition
 <b>DANGER!</b>	Advice to the user of Potential Risk of serious injury or death if the advice is not followed
 <b>WARNING!</b>	Advice to the user of a potential risk of injury if the advice is not followed
 <b>CAUTION!</b>	Advice to user that potential damage to equipment may occur if the advice is not followed
<b>NOTE:</b>	General advice or best practice
	Reference to a related document
	This vehicle is NOT crash tested. This label is also located on the rear frame of the scooter next to the Anti-tip wheels.
	Secure with straps for transport. Do not travel on-board scooter
	Quick Start Guide

**1.**  → 

---

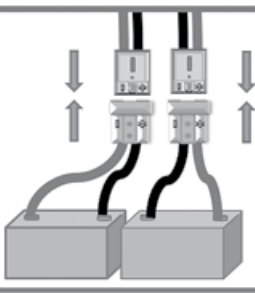
**2.** 

22217029

### Quick Start Guide

See Sections:

**5.0 Seat Removal**

**5.3 Batteries**

Affix Serial Number Label Here

## Use

### Intended Use of Scooter's:

Class 2 scooter's are not for road use and have a maximum speed of 4mph.

Class 3 scooter's are usually large in size, not necessarily intended for indoor use but capable of travelling longer distances and negotiating outdoor obstacles and have a maximum speed of 8mph in the United Kingdom. Higher speeds are permitted in other countries.

They are intended for use in public places and similar locations where there are pavements, pedestrian paths or floors that have hard and firm surfaces. The safe limit for slopes and obstacles shall be observed.

They may be used on the roads in compliance with local country traffic law. They are intended for a user who has difficulty in walking or limited mobility and is for their own personal use.

The maximum user weight limit, includes both the user and any weight of accessories fitted to the scooter), is marked on the serial number label, which is affixed to the seat post.

Warranty can only be taken on if the product is used under the specified conditions and for the intended purposes. No unauthorised modifications should be made to the Scooter. Only approved parts and accessories shall be fitted.

The intended lifetime of the scooter is 5 years. Please DO NOT use or fit any 3rd party components to the scooter unless they are officially approved by Sunrise Medical.

## Area of application

The electrical power, simple steering and automatic braking make the Scooter suitable for people who have limited mobility due to, for example:

- Joint pain and/or stiffness due for example to Arthritis or Rheumatism
- Difficulty breathing due to Respiratory or Heart Conditions.
- Difficulty walking due to Stroke
- Certain cases of Obesity

The following should be taken into consideration in relations to the provision of the scooter and any specific options available:

- The users body size, weight including the distribution of body weight.
- The mass of any carry on or stowed items should be added to the users body mass and together should not exceed the maximum load of the scooter.
- The user's physical and psychological constitution.
- The age of the user, their living conditions and the environment in which the scooter is going to be used, e.g. home surroundings and the intended area of use.

If in doubt, please consult a health care professional to ensure the user is not exposed to unacceptable risks. A risk assessment may be required in certain circumstances.

Sunrise Medical is ISO 9001 certified, which ensures quality at all stages of the development and production of this scooter.



### Important:

Do not use your scooter until this manual has been read and understood.

## Features

### Features of Sterling S-Series Scooters:

Due to their modular design, simplicity and wide range of adjustments, the Sterling S-Series Scooters are a perfect choice for easy service, refurbishment and recycle requirements.

As a part of our ongoing product improvement initiative, Sunrise Medical reserves the right to change specifications and design without notice. Further, not all features and options offered are compatible with all configurations of the scooter.

All dimensions are approximate and may be subject to change.

1. Control Panel
2. Wig-Wag Throttle
3. Adjustable Seating
4. Flip-up Armrests
5. Free-wheel Lever
6. Battery Cover
7. Alloy Wheels
8. Foot-board
9. Front Bumper
10. Basket
11. LED Lights
12. Rear View Mirrors

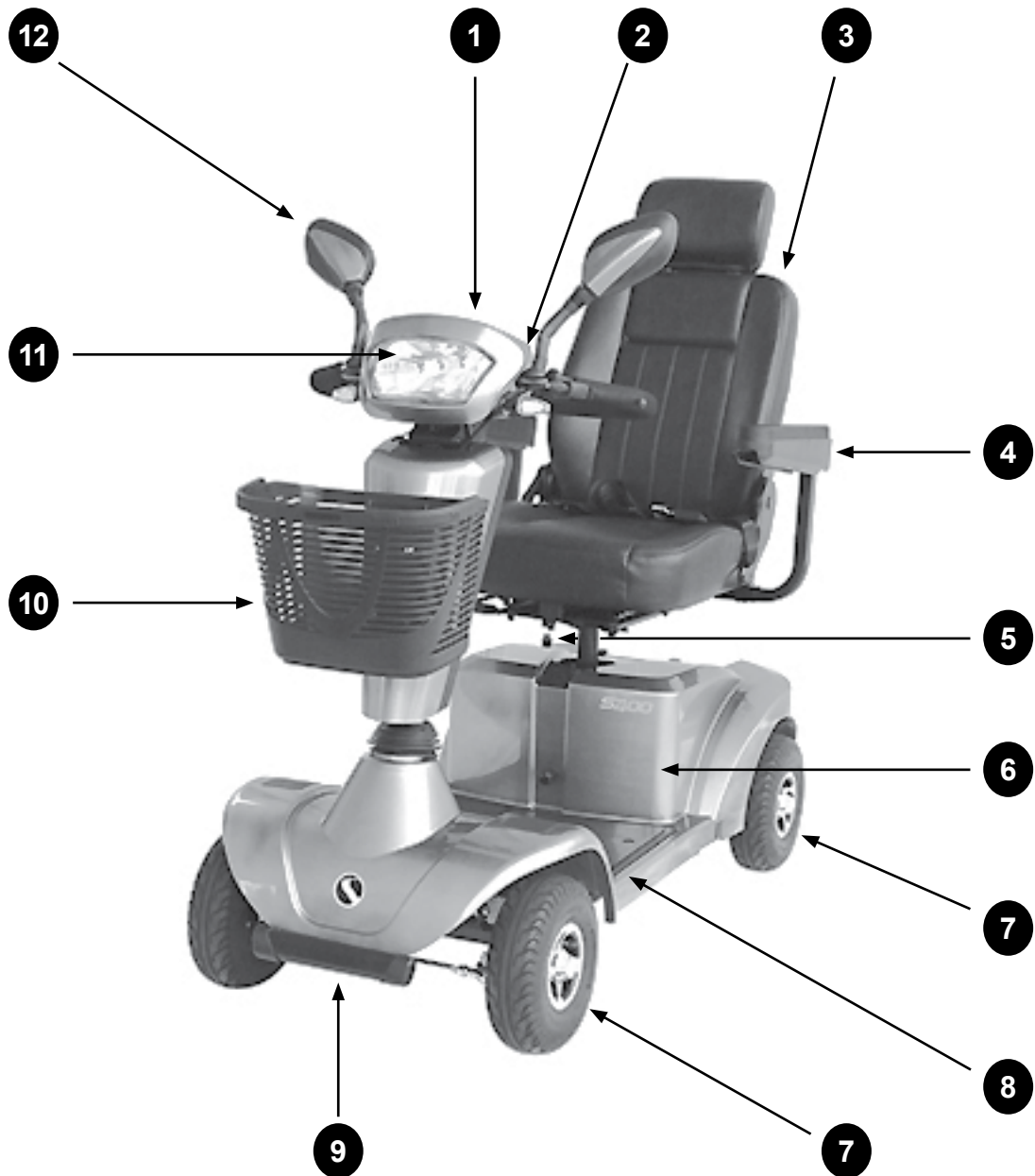

## Contents

Foreword	3
Label Explanation / Word definitions	3
Use	4
Area of application	4
Features	5
Contents	6
1.0 Your Scooter	6
2.0 How to Use This Manual	7
3.0 Label Explanation/Definitions	7
4.0 Safety Information	8
5.0 Assembly & Options	14
6.0 Using The Scooter	20
7.0 Scooter Control System	24
8.0 Troubleshooting - Display	28
9.0 Batteries and Charging	30
10.0 Adjustments	33
11.0 Cleaning	34
12.0 Shipping and Storage	34
13.0 Disposal	36
14.0 Torque Settings	36
15.0 Specification Sheets	36
16.0 Guarantee	40
17.0 Service Advice/History	40
18.0 Service and Maintenance	41
19.0 Nameplate	44

**NOTE:** If you have any queries about the use, maintenance or safety of your scooter, please contact your local approved Sunrise Medical service agent. If you do not know of an approved dealer in your area or have any other questions please write or telephone:

Sunrise Medical  
Thorns Road  
Brierley Hill  
West Midlands  
DY5 2LD  
England  
Phone: 0845 605 66 88  
Fax: 0845 605 66 89  
www.SunriseMedical.co.uk

**NOTE:** Please keep a note of your local service agent's address and telephone number in the space below. In the event of a breakdown, contact them and try to give all relevant details so they can help you quickly.

### DEALER ADDRESS/STAMP



## 1.0 Your Scooter

### 1.1 PRODUCT INFORMATION:

We at Sunrise Medical want you to get the best out of your Sterling S-Series scooter. This Owner's Manual will familiarise you with the scooter and its features. It contains hints on everyday usage and general care in addition to information on the high quality standards which we adhere to and details about the guarantee.

Your scooter should be delivered ready for your use; there are a wide range of accessories available for the scooter. For further information about these you should contact your Sunrise Medical authorised dealer.

Your scooter will reach you in excellent condition having been personally inspected before leaving our factory. Following the guidelines for maintenance and cleaning your scooter will maintain its first class condition and give you complete satisfaction.

This Scooter is designed for comfort, safety and durability and has been exhaustively researched and tested by our experts. The Sterling S-Series S400-S425 is classified as a category B vehicle and the S700 as a category C under the European scooter standard EN 12184.

It is intended for the use of people of all ages who may have difficulty walking distances or for periods of time. It is ideal for indoor, (S400-425), shopping malls and outdoor use, (S700 for outdoor use) and suitable for users up to 160kg for S700 model, 150kg for S425 model and 136kg for S400 model. Variation in load weight can affect performance. The scooter is designed to be driven on paved or tarmac footpaths and roads but should not be driven through mud, water, snow or loose unstable ground. If you are in any doubt as to the suitability of the power scooter, contact your local Sunrise Medical approved supplier for clarification, prior to commencing use.

**NOTE:** Using your scooter on walk-ways and roads may be subject to the applicable legal requirements of National Road Laws and or Road Traffic Laws



It is very important to read the relevant section of the owner's manual when making any minor adjustments. Consult the Technical Manual or your local Sunrise Medical authorised dealer for more complex adjustments.

**NOTE:** Sunrise Medical recommend, as a safeguard that you review the various insurance policies available for scooter users.

## 2.0 How to Use This Manual

### 2.1 INTRODUCTION:

The scooters shown and described in this manual may not be exactly the same in every detail as your own model. However, all instructions are still entirely relevant, irrespective of detail differences.

**NOTE :** The manufacturer reserves the right to alter without notice any weights, measurements or other technical data shown in this manual. All figures, measurements and capacities shown in this manual are approximate and do not constitute specifications.

### 2.2 GUARANTEE:

Please fill in the relevant details and return to us to register your entitlement. **THIS IN NO WAY AFFECTS YOUR STATUTORY RIGHTS.**

### 2.3 WARRANTY-REPAIR-SERVICE CONDITIONS:

- 1) The repair or replacement will be carried out by an authorised Sunrise Medical dealer/service agent.
- 2) Should your scooter require attention under these arrangements, notify the designated Sunrise Medical service agent immediately giving full information about the nature of the difficulty. Should you be operating the scooter away from the locality of the designated Sunrise Medical service agent, work under the "Warranty Conditions" will be carried out by any other service agent designated by the manufacturer.
- 3) Should any part of the scooter require repair or replacement, as a result of a specific manufacturing or material defect, within **twenty four months**, (6 months for batteries), from the date on which the possession of the scooter was transferred to the original purchaser, and subject to it remaining within that ownership, the company will supply free of charge replacement, (or repaired), parts, to the authorised dealer/service agent. If you are unsure who your local servicing agent is: Please contact Sunrise Medical using the contact details on the previous page.
- 4) Any repaired or replaced part will benefit from these arrangements for the balance of the warranty period applicable to the scooter.
- 5) Parts replaced after the original warranty has expired are covered for a further twelve months.
- 6) Items of a consumable nature will not generally be covered during the normal warranty period, unless such items have clearly suffered undue wear as a direct result of an original manufacturing defect. These items include amongst others; upholstery, tyres, inner tubes, batteries, motor brushes etc.
- 7) The above warranty conditions apply to all scooter parts for models purchased at full retail price.



8) Under normal circumstances, no responsibility will be accepted where the scooter has required repair or replacement as a direct result of....

- The scooter or part not having been maintained or serviced in accordance with the manufacturer's recommendations, as stated in the Owner's Manual and/or Service Manual. Or failing to use only the specified original equipment parts.
- The scooter or part having been damaged by neglect, accident or improper use.
- The scooter or part having been altered from the manufacturer's specifications, or repairs having been attempted prior to the service agent being notified.

9) Warranty can only be provided if the product is used under the specified conditions and for the intended purpose.

**The expected lifetime is 5 Years.**

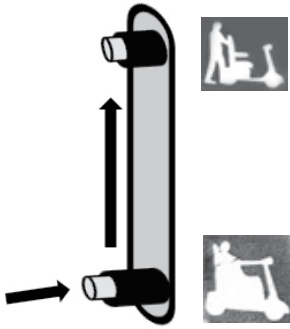
## 3.0 Label Explanation/Definitions

LABEL	MEANING
	This label shows the model number, serial number, max weight and manufacturer details.
	This label shows the position of the free-wheel lever..  FREE-WHEEL  ↑↓  DRIVE
	This label shows the location of the power ON and OFF for the scooter and 'read the user manual' warning.

## 4.0 Safety Information

If you follow the instructions given in this manual, you will enjoy many trouble-free years of use.

### 4.1 GENERAL WARNINGS:

#### WARNING!

- The S700 is primarily intended for outdoor use, it is therefore larger than the S400 and S425. Due to the increased dimensions, when using the S700 within the confines of a building, please ensure that the building has suitable emergency escape routes capable of allowing free access/ingress for you and your scooter.
- This scooter can be used on the road, ensure all local traffic regulations and health requirements, (such as eye sight), are understood and adhered to.
- Load data always refers to one single person as operator.
- The scooter is authorised for use by one person.
- Do not operate your Scooter whilst under detrimental influence of alcohol, drugs or bouts of severe/acute illness .
- Please observe all relevant rules and regulations pertaining to pedestrians and road users, at all times.
- Always ensure that your scooter is switched off before attempting to mount or dismount.
- Always ensure that you are able to operate all controls from a comfortable position. Paying attention to your posture is essential to ensure your continued comfort and well being.
- Always make sure that you can be seen clearly, especially if you intend using your scooter in poor light.
- Switch on the scooter lights to make yourself visible when there are low levels of light , day or night.
- The scooter has been built to match the needs of the majority of users. If a personal risk assessment highlights specific needs, the scooter may need to be adjusted and/or reprogrammed.
- Do not let children or others use your scooter.
- Do not lift or hoist the scooter by any detachable parts such as seat, arm rests etc.
- Department at the address shown on page 6.
- Do not attempt inclines when any of the following accessories are fitted, rear storage bag, rear mounted wheelchair/walker holder or oxygen bottle holder, as they may cause the scooter to become unstable.
- Do not attempt to ascend or descend escalators or stairways.

#### CAUTION!

### 4.2 FEATURES AND OPTIONS:

Some of the options shown in this manual may not be available in your country and Some features may Be restricted by, (e.g. max. speed, user weight limit, range, etc.).



Any limitations are marked on the order form, in the technical manual and in this owner's manual. For further information please consult your Sunrise Medical authorised dealer.

#### DANGER!

### 4.3 PRELIMINARY CHECKS:

- Always check that Drive is selected before setting the scooter in motion.
- The scooter emits an audible warning when Free-wheel is selected and will not allow the scooter to drive.
- You should not try to manoeuvre at full speed.
- If you have to make a sudden turn, slow down first by releasing the control lever or the speed control feature, this is very important if you are going down a hill.
- Failure to slow down during a manoeuvre may result in your overturning the scooter.
- Always check that the scooter is switched off before trying to get on or off.
- Always check that you can be seen clearly, especially if you are using the scooter in conditions of low visibility.

### 4.4 EMERGENCY BRAKING:

#### WARNING!

Turning the ON-OFF key to the OFF position during driving will cut the power and immediately apply the brake. This method of stopping is not recommended except for emergencies, since the stop will be extremely sudden.

#### CAUTION!

Routine use of emergency braking will cause damage to your Scooter.



#### 4.5 TYRES:

The tyres of a scooter suffer wear depending on how much the scooter is used. Check them regularly, especially for inflation pressure, according to the service instructions in this manual.

Each tyre pressure should be:

S400/S425 = 2.7 bar (40 P.S.I.)

S700 = 2.7 bar (40 P.S.I.).

See section 5.26 for solid tyre information.

#### DANGER!

Never inflate the tyres with a service station air pump. It is recommended that you use a manual pump or a pump fitted with a pressure regulator (manometer).

#### 4.6 KERBS, (FIG 4.1):

#### DANGER!

- Be aware of other vehicles and pedestrians when kerb climbing.
- Do not attempt to mount kerbs in excess of 50 mm (2"), for S400-S425 or 100mm (4") for S700.
- Always mount and dismount kerbs with caution and directly facing the kerb.
- Do not attempt to mount or dismount kerbs in reverse.
- Do not attempt to descend from, a kerb of more than 50 mm. height.
- Do not attempt to ascend high kerbs, steep slopes or cambers due to the risk of falling out of the scooter or tipping over.
- Do not attempt to ascend any kerb in the vicinity of a drain cover, uneven surfaces, or gravel covering.
- Do not attempt to climb or descend any kerb at an oblique angle. Approach only at an angle of 90° with at least 500mm run-up.
- Do not attempt kerb climbing/descents when any of the following accessories are fitted, rear storage bag, rear mounted wheelchair/walker holder or oxygen bottle holder, as they may cause the scooter to become unstable.

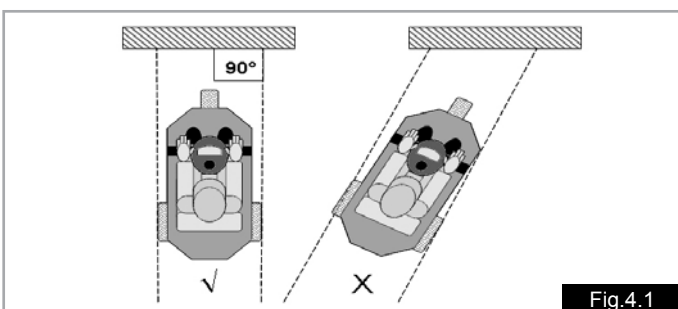

#### 4.7 TRANSPORTATION IN VEHICLES:

This scooter is not suitable to use as a seat in a vehicle.



**Not crash tested**

#### DANGER!

A scooter secured in a vehicle will not provide the equivalent level of safety and security of a vehicle seating system. It is always recommended that the user transfers to the vehicle seating.

**NOTE:** For transportation by road, rail, sea or air please refer to Section 12, Shipping and Storage.

#### 4.8 FREE-WHEEL DEVICE, (FIG.4.2):

The scooter has two modes of movement:

##### Drive or Free-wheel.

- DRIVE = All movement, including braking, is exclusively controlled by operation of the electronic control system.
- FREE-WHEEL = Movement is by manual means, e.g. pushed or by gravity, (pot holes, kerbs, hills or inclines etc).

Push the red knob down and forward to put the scooter into free-wheel, (Fig.4.2).

#### DANGER!

- Only use the free-wheel function to push the scooter manually from one spot to another.
- Keep in mind that while the free-wheel system is in operation, the scooter is without an automatic braking system.
- Selecting free-wheel causes a loud audible warning beeping tone from the scooter horn.
- For safety reasons the scooter can no longer be moved using the control levers.
- Do not operate the free-wheel device whilst seated in the scooter
- The free-wheel device should only be operated by a person who has the strength and agility to be able to fully manoeuvre the scooter safely, during free-wheel.
- Always put the scooter back in drive.
- Always check that drive is engaged before using the scooter.
- Do not disengage the free-wheel on or near a slope.
- Do not allow yourself to be pushed by others, or towed, whilst the scooter is in free-wheel.

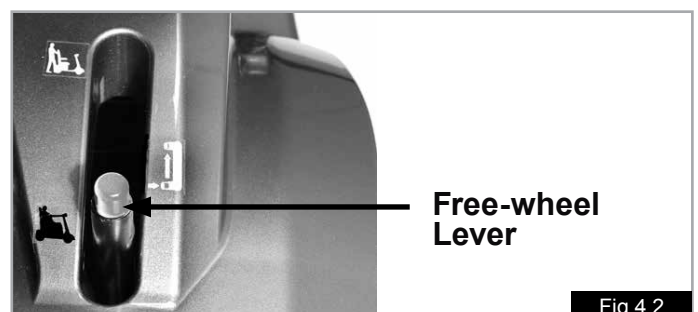

## **WARNING!**

### **4.9 EMC - RADIO TRANSMITTING DEVICES:**

When operating two-way radio, walkie-talkies, C.B, amateur radio, public mobile radio and other powerful transmitting devices the scooter should be brought to a halt and turned off. The operation of cordless, mobile telephones and cell phones including hands-free devices is permitted but if abnormal driving performance of the scooter is encountered then the scooter must be brought immediately to a halt and turned off.

**NOTE:** the electrical systems of the scooter may disturb the performance of alarm systems in retail shops.

## **DANGER!**

### **4.10 SHARP TURNS:**

Full speed turns should not be attempted. If you need to turn sharply you must reduce your speed with the control panel speed setting. This is particularly important when travelling across or down a slope. Disregarding this advice could lead to your scooter tipping over.

## **DANGER!**

### **4.11 WEIGHT LIMIT:**

- The user, plus options and accessories, plus items carried should never exceed the total weight as listed in section 1.1 .
- Never sit in the scooter whilst weight training. Exceeding the weight limit is likely to damage the seat, frame or fasteners and may cause severe injury to you or others from scooter failure
- Exceeding the weight limit will void the warranty.
- Do not hang shopping bags from the handlebars as they could swing and cause loss of steering control.

### **4.12 HOT/COLD SURFACES:**

## **WARNING!**

After prolonged use, the drive unit motors will produce heat, which is radiated through the motors' outer casing.

- Do not remove the rear drive unit battery cover for at least 30 minutes after using the scooter.
- Do not touch the motors' outer casing for at least 30 minutes after using the scooter, to allow it to cool.
- Not only motors can become hot during the operation of the scooter, the seat upholstery material and armrests may heat up when standing in the sun.
- Be aware that in extremely cold weather, exposed metal parts can present a freeze burn hazard, particularly if the hands are wet.

### **4.13 ROAD CAUTION:**

Please show the utmost consideration for pedestrians and other road users.

## **DANGER!**

- Remember that the last thing a car or lorry driver expects to see is a scooter driving off the kerb into the road.
- If in any doubt, do not risk crossing the road until you are certain that it is safe.
- When crossing roads, do so as quickly as possible; there may be other traffic.
- Be seen! Always wear something bright such as light coloured clothing, a reflective tabard or day glow vest.
- At night, in dull conditions or in poor visibility, always use the lights, particularly when driving on the road.
- Obey all of the rules for pedestrians and traffic.
- Remember, on the road you are traffic, on the footpath and when crossing the road you are a pedestrian.
- Whilst driving on the road do not drive up one-way streets the wrong way, use the footpath with the speed control set at the appropriate speed, (less than 4mph-6kph).
- Do not hang bags off the handle bars or tiller adjustment lever.

### **4.14 ADVERSE CONDITIONS:**

## **DANGER!**

- Be aware that when driving your scooter in adverse conditions, e.g. on wet grass, mud, ice, snow or other slippery surfaces, you may experience a reduction in the grip and traction of your scooter. We recommend you take extra precautions in these conditions, particularly on hills and slopes; your scooter could become unstable or skid causing possible injury.

## **DANGER!**

When you are using a Powered Scooter or wheelchair, take extra care with loose or long items of clothing. Moving parts, such as wheels, can be potentially dangerous or even fatal if clothing becomes entangled.

**NOTE:** Extreme variances in temperature may trigger the self protect mechanism in the control system. If this occurs the control system will temporarily shut down to prevent damage to the electronics or the scooter.

#### 4.15 RAMPS:

##### **DANGER!**

- When using a ramp for access, please ensure that it is capable of taking the combined weight of the scooter and yourself.
- When a ramp is being used, please ensure that the ramp is stable and properly secured.
- Always approach the ramp head-on and exercise caution.
- Please ensure the ramp is suitable for the purpose you are using it for.
- Maximum ramp angle: S700 = 10° (18%), S400/S425 = 8° (14%)
- Follow all the user instructions supplied with the ramp.
- Be aware that accessories attached to the scooter, may affect the overall stability.
- Do not attempt to use ramps when any of the following accessories are fitted, rear storage bag, rear mounted wheelchair/walker holder or oxygen bottle holder, as they may cause the scooter to become unstable.

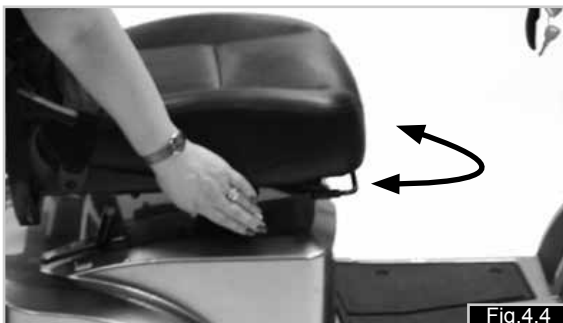

#### 4.16 TRANSFER TO AND FROM THE SCOOTER

##### **Mounting your scooter**

1. Ensure that the key is turned to the off position.
2. Stand at the side of the scooter and lift the nearest arm rest, (Fig.4.3).
3. Push the seat rotate lever forwards and rotate the seat until it faces you, (Fig. 4.4 - 4.5).
4. Make sure that the seat is locked securely into position.
5. Position yourself comfortably in the seat (Fig.4.6).
6. Push the seat rotate lever forwards and rotate the seat until facing forward (Fig.4.7).
7. Make sure that the seat is locked securely into position and the arm rest is down, (Fig.4.8).
8. Ensure that your feet are placed firmly on the foot board of the scooter and that you can reach all the controls comfortably, (Fig.4.8).



##### **Dismounting your scooter**

1. Bring your scooter to a complete stop.
2. Make sure that the key is turned to the off position.
3. Push the seat rotate lever forwards and rotate the seat until you are facing the side of the scooter, (Fig.4.6).
4. Make sure that the seat is locked securely into position and that both feet are on the ground.
5. Carefully get out of the seat and stand by the side of your scooter, (Fig.4.3).
6. You may leave the seat in this position or return it to facing forward.



#### 4.17 ANTI TIPS:

##### **WARNING!**

- Ensure the anti tips are fitted before using the scooter.
- Ensure that anti tips are not damaged or worn before using your scooter.
- Attendants must be aware of the location of the anti tips to prevent feet being trapped underneath causing injury.
- Do not allow adults or children to stand on the anti tips, or any other part of the scooter as this could cause the scooter to become unstable.

#### 4.18 USE ON A SLOPE:

Your scooter has been designed and tested to allow its use on slopes or gradients of up to: S700 = 10° (18%) S400/S425 = 8° (14%).

To improve stability lean forward when driving uphill. Set the seat to its lowest height in the furthest forward position and set the back upright. When travelling downhill sit in an upright position or recline the back rest slightly to compensate.

##### **WARNING!**

- Do not exceed the maximum slope of: S700 = 10° S400/S425 = 8°.
- Stop and return the back rest to an upright position before attempting to climb a slope. Failure to do this may cause the scooter to become unstable.
- If you are in any doubt about the capabilities of your scooter on a slope then do not attempt to drive up or down the slope/kerb; try to find an alternative route.
- Wherever possible always travel up or down the slope directly facing the slope, (Fig.4.9).
- Never attempt a non-stop "U" turn when going up or down steep slopes, (Fig.4.9).
- Be aware that accessories attached to the scooter, may affect the overall stability.

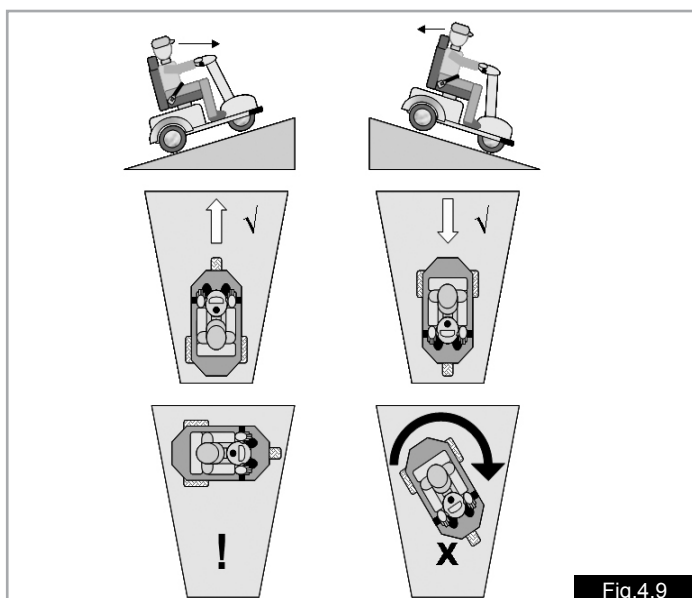

Fig.4.9

#### 4.19 GRADIENTS: ASCENTS:

When going uphill, keep the scooter moving if it is safe and clear to do so.

Manoeuvre by using gentle tiller and throttle movements. The seat should be set to its lowest height in its furthest forward position and the back should be upright.

##### **WARNING!**

- If you have stopped on a hill, you should start off again slowly.
- Avoid sudden acceleration or hard braking.
- Avoid hard turns.
- Be aware that stopping distances may increase when traveling down hill.

#### 4.20 GRADIENTS: DESCENTS:

##### **WARNING!**

- On descents, it is important not to let the scooter accelerate beyond its normal level of ground speed.
- It is safer to proceed slowly down steep descents (below the speed of 3mph, 5kph) and stop, if any anxiety arises regarding the descent.
- If the scooter picks up speed, release the control lever to stop all forward movement, then restart slowly and do not allow the speed to increase beyond a comfortable level.

#### 4.21 LAP BELT:

Before using your scooter ensure the Lap belt is worn and correctly adjusted before use.

The lap belt is fitted to the scooter as shown in the fitting photographs, (Fig.4.10 - 4.26). It is important that the belt is fitted correctly and is not twisted.

##### **To lock the belt:**

Pull the buckle over your lap and push firmly into the slot in the receiver, (1).

Ensure that there is no excess belt material, and the belt is tensioned correctly. (Fig 4.10)

##### **To release the belt:**

Push the red button marked 'PRESS' to release the belt, (2), (Fig 4.10).

##### **DANGER!**

- The Lap Belt is fixed so that the straps sit at an angle of approximately 45°, and when correctly adjusted should not allow the upper body to slip down in the seat, (Fig.4.11)
- The lap belt is not suitable for use when the scooter and occupant are transported in a vehicle.

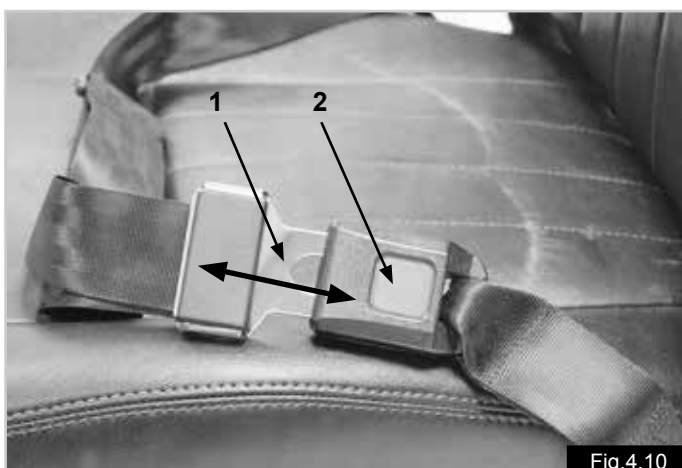

Fig.4.10

- The lap belt must be checked on a daily basis to ensure it is adjusted correctly and it is free from any obstruction or adverse wear.
- Failure to make sure that the lap belt is secure and adjusted prior to use could cause serious injury to the user. E.g. too loose a strap may allow the user to slip down in the seat and risk suffocation.

**Maintenance:**

- Check lap belt, and securing components; at regular intervals for any sign of fraying or damage.
- Replace if necessary.
- Clean the lap belt with warm soapy water and allow to dry.
- The lap belt should easily allow a hands width of space between the body and the belt, (Fig.4.12).
- Sunrise Medical also recommend that the fit of the belt is checked on a daily basis to reduce the risk of the end user inadvertently re-adjusting the belt to an excessive length.
- If in doubt about the use and operation of the seat belt then ask your healthcare professional, dealer, or carer for assistance.

For your comfort, the Lap Belt must be correctly fitted to the scooter. If you are unsure about the fitting or operation of this option, please contact your approved Sunrise Medical dealer.



Fig.4.12



Fig.4.13



Fig.4.14

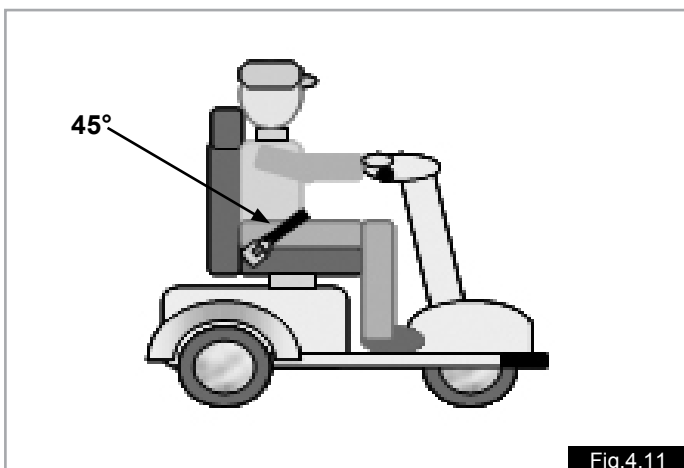

Fig.4.11

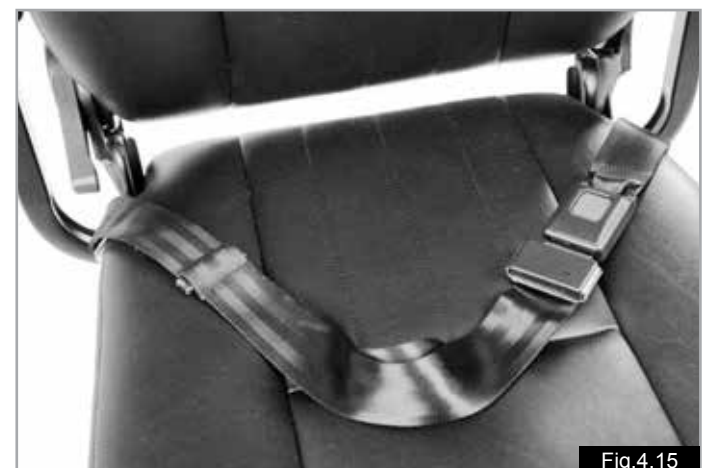
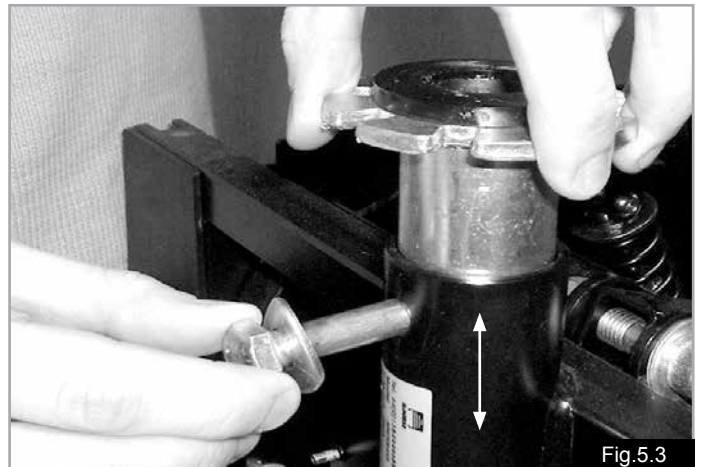

Fig.4.15

## 4.22 SAFETY CHECKS

### WARNING!

- The scooter driver plus items should never exceed the total weight listed in section 1.1.
- Before you use the scooter, check that it is not in free-wheel and that all of the controls are functioning correctly.
- If you discover any scooter malfunction, take it to be repaired or reset. Your dealer can help you to find the fault and correct it.
- Make sure batteries are charged. Do not use the scooter when battery is low. The scooter may come to a sudden, unexpected stop.
- Be aware that there is a point during every transfer when the scooter seat is not below you.
- Use extra care when you drive your scooter in reverse. If one of the wheels hits an obstacle, you could lose control of the scooter or fall out.
- Never use your scooter on a slope unless you are sure you can do so without losing traction.
- When travelling along, always ensure the backrest is upright and the seat faces forwards.
- Lift the scooter only by non-detachable parts of the main frame.
- Never short-circuit electrical connections as you could cause an explosion.
- Do not use the scooter if any of the tyres are damaged or under/over-inflated.
- When using mobile phones you should switch the scooter off.
- Do not smoke whilst on-board the scooter.
- If you take a break from driving, but remain seated in the scooter for more than just a moment, switch the scooter off at the ignition key.



## 5.0 Assembly & Options

### 5.1 SEAT ADJUSTMENTS

#### WARNING!

Observe correct lifting techniques at all times when lifting components over 10kg.

**Flip Up Armrests,** (Fig 5.1). By pulling up on the front end of either armrest, the armrest will flip back for easy transfer on and off of your scooter.

**Adjusting the Armrest Width,** (Fig.5.1).

Loosen the two hand wheels, (A) and pull out the armrests to the desired width. Tighten the hand-wheels firmly, (A).



### Removing the Armrests, (Fig.5.1).

Loosen the two hand wheels, (A) and pull the armrests completely out of the receiver assembly. Store in a safe place

**Seat Rotate Lever** (Fig 5.2): This is found under the right side of the seat. Push it forwards to allow the seat to rotate 360 degree and release to lock in any 45 degree position desired.

**Seat Height Adjustment:** (Fig 5.3) The seat post is height adjustable, providing 3 height positions. Carefully unscrew the bolt and nut, and insert into desirable position and tighten nut to a torque value of 25 Nm.

**Sliding Mechanism** (Fig. 5.4): This allows forward and backward movement of the seat. Pull up lever found on the right of the seat and use legs and body to move to the required position and release lever.

### Seat Removal (Fig 5.5 - 5.8)

1. Push the seat rotate lever forwards and turn seat 45°.
2. Stand behind the seat, flip up the arm rests and fold the backrest forward by lifting up the backrest adjustment lever.
4. Place hands on either side of seat base, push the seat rotate lever forwards and lift the seat vertically keeping back posture upright. Bend the knees if required.

### **WARNING!**

The seat is heavy, (35 kg). Please seek assistance.



### 5.2. ANTI-TIP WHEELS:

These are factory fitted and should not be removed. The anti-tip assembly is bolted to the rear frame of the scooter, (Fig 5.8).

### **WARNING!**

Never use the scooter without the anti-tip wheels fitted.

### 5.3 BATTERIES:

 Read section 9.0 of this manual for additional battery and charging information.

#### DANGER!

- Do not smoke near, or expose the batteries to direct heat (i.e. naked flame, gas fire).
- Do not attempt to change the fuses yourself.
- Do not attempt to by-pass the fuse as this would be very dangerous and could cause a fire.
- If you suspect a fault, contact your Sunrise Medical authorised dealer as soon as possible.
- Do not short circuit the battery terminals. Remember tools, jewellery etc can conduct and if dropped across the battery terminals may cause severe burns and/or explosion!
- Ensure the battery terminal covers are fitted.
- Batteries are heavy. Use correct lifting techniques when removing them from the scooter.
- Always use the handles provided to lift the batteries.
- Always refit the retaining bar after refitting or replacing the batteries.

#### Battery Removal:

1. Remove the seat (Fig 5.5 - 5.8 previous page)
2. Remove the Battery cover by unscrewing the three hand wheels and lifting it off. Note: please disconnect the plugs for rear lights, (Fig 5.9 - 5.10)
3. Pull the two halves of the plastic battery connector plugs apart, (Fig 5.11).
4. If replacing the batteries or battery looms, pull back the terminal cover and disconnect battery terminals, using a 11.0mm spanner (Fig 5.12).
5. Remove or release the battery retaining straps.
6. Bend knees with battery positioned centrally in front of you, rest your forearms on your knees for support (Fig 5.13).
7. Grab battery handle with both hands (Fig 5.13).
8. Lift vertically by straightening legs, keeping back posture upright (Fig 5.14).
9. Move the battery to a safe place, keeping back posture upright and bending knees when setting it down.

#### Battery Weights:

Battery Type		Weight kg
38 Ah @ 20 hrs.	S400	12.5
55 Ah @ 20 hrs.	S425	18.0
75 Ah @ 20 hrs.	S700	24.6





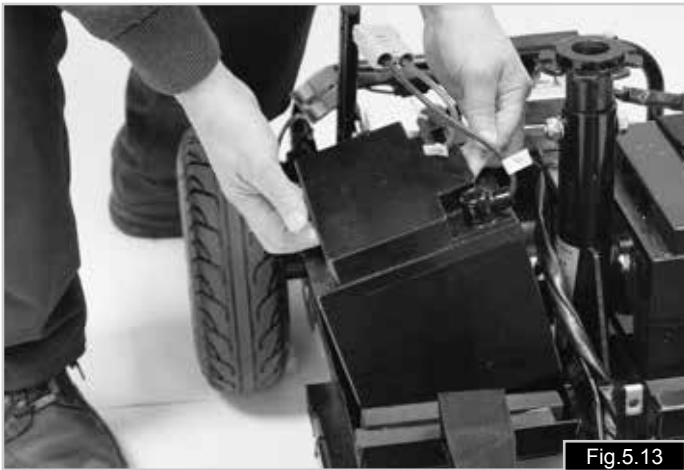

Fig.5.13



Fig.5.14

#### 5.4 CRUTCH/WALKING STICK HOLDER Fig 5.15

##### **WARNING!**

- Ensure that the crutch holder is securely fastened to the seat back rest.
- Ensure that the crutch is not interfering with the mechanisms of the scooter.
- Ensure that the crutch does not protrude from the sides of the scooter.
- Do not attempt to remove the crutch whilst the scooter is in motion.
- Always come to a complete stop and turn off the power to the controls before attempting to remove the crutch. This will avoid accidentally operating the scooter.



Fig.5.15

#### 5.5 LIGHTS AND INDICATORS,

##### Front Fig.5.16

##### Rear Fig 5.17

Ensure that the lights and indicators are functioning correctly and lenses are clean before going outdoors at night or in poor visibility.

**NOTE :** The light clusters fitted to the scooter comprise of LED lights. They are very efficient and reliable, which means that there is no “bulb” to change. Should a light cluster become damaged, please contact your local Sunrise Medical approved servicing agent for any warranty, service or repair work required.



Fig.5.16



Fig.5.17

## 5.6 SEAT COVER:

This option offers additional protection to the seat, (Fig.5.18).

### **WARNING!**

Ensure the seat cover is correctly fitted and is not obstructing the controls of the scooter or in contact with the scooter moving parts.

## 5.7 HEAD REST:

The head rest is supplied as standard fitted to the seat. To adjust the height, squeeze the clip on the left hand stem guide and move the head rest until it clicks into the nearest notch to the desired position. To remove the head rest do the same, but lift the head rest completely out, (Fig 5.19).

## 5.8 REAR STORAGE BAG:

The bag is used for storing items, and is strapped to the back of the seat. Please follow fitting instructions provided with the bag, (Fig.5.20).

### **WARNING!**

- Maximum Carrying Load = 10 kg.
- The weight of the driver plus any luggage, should not exceed the maximum user weight of the scooter.
- Do not attempt inclines with this accessory fitted, as it may cause the scooter to become unstable.

## 5.9 REAR MOUNT WHEELCHAIR/WALKER HOLDER:

The rear mount is used for carrying a wheelchair or walker items, and is mounted to the rear accessory mount on the back of the seat. Please follow fitting instructions provided with rear mount, (Fig.5.21).

### **WARNING!**

- Maximum Carrying Load = 15 kg.
- The weight of the driver plus any luggage, should not exceed the maximum user weight of the scooter.
- Be aware that attached accessories increase the effective footprint of the scooter.
- Take extra care when manoeuvring if you have a Rollator, walker, or wheelchair on board.
- Ensure that the load is secured properly before moving off.
- Be aware that the load you are carrying may obscure the rear lights on the scooter. If this is the case, Please use the foot path whilst carrying the load, particularly at night.
- Do not attempt inclines with this accessory fitted, as it may cause the scooter to become unstable.



### 5.10 SCOOTER CAPE AND LEG CAPE:

These options offers additional protection for the scooter user in poor weather conditions, (Fig.5.22).

#### **WARNING!**

Ensure the capes are correctly fitted and are not obstructing the controls of the scooter or in contact with the scooter moving parts.

### 5.11 OXYGEN BOTTLE HOLDER:

The Oxygen Bottle Holder (A), fits to the seat via the straps provided.

The holder is designed to accept a 4.0 kg bottle, (Fig.5.23).

#### **WARNING!**

- While you are taking Oxygen, observe all safety regulations pertaining to the use of Oxygen.
- Do not enter an area where naked flames may be used.
- Do not smoke.
- Do not use transmitting devices such as mobile phones etc.
- Do not attempt inclines with this accessory fitted, as it may cause the scooter to become unstable.

### 5.12 REAR VIEW MIRRORS:

Your scooter is fitted with rear view mirrors as standard. To adjust the mirrors, while seated, simply hold the mirror head and gently move it into the position that allows you to see clearly behind you. Adjust both mirrors to enable complete rear vision for both sides of the scooter, (Fig.5.23).

#### **CAUTION!**

The mirror has an articulated joint in its stem, take care not to use excessive force when adjusting.

To remove the mirror; use a 14.0 mm spanner to loosen the securing nut, then support the mirror stem and turn it anti-clockwise until it screws out of the handle bar. To refit the mirror, reverse the above procedure tightening the securing nut to a torque of 10-15 Nm, (Fig.5.23).

### 5.13 SOLID TYRES:

Solid tyres are available as an option. The solid tyres offer greater security for the user because they cannot be punctured.

**NOTE:** Solid tyres have the effect of producing a firmer ride, (Fig.5.24).



Fig.5.22



Fig.5.23



Fig.5.24

#### 5.14 SCOOTER STORAGE COVER:

The scooter storage cover will protect your scooter when stored in outside conditions, (Fig.5.25).

#### **⚠️WARNING!**

Never attempt to drive or move the scooter with the storage cover fitted.

#### 5.15 OFFBOARD CHARGING KIT:

The offboard charging kit allows the charging of spare batteries for your scooter.

#### **⚠️WARNING!**

Before charging batteries read the charging section of this manual.

#### 5.16 HEAVY DUTY SUSPENSION KIT:

The heavy duty suspension kit allows for a firmer ride experience on your scooter. The kit is recommended to be installed by your Sunrise Medical dealer.

#### 5.17 WARNING TRIANGLE (GERMANY):

The warning triangle provided with your scooter (over 6.0 kph models) is approved for road use and should not be removed.



### 6.0 Using The Scooter

#### **⚠️WARNING!**

- Parts of the scooter are heavy. Please use correct lifting techniques.
- If you are unsure about lifting or removing any assemblies, or performing any other task requiring physical effort, get someone to help you who can manage the task or call your local Sunrise Medical dealer.

#### 6.1 PREPARING FOR STOWED TRANSPORTATION:

Remove the batteries as described in section 5.3.

To lift the batteries please use the handles on the webbing cradle surrounding the batteries.

Ensure that the seat is removed, (section 5.1) or folded and the tiller is folded in it's lowest position.

#### 6.2 TO USE THE SCOOTER AGAIN:

Reverse the above procedure

Refit the batteries.

#### **⚠️WARNING!**

- Never lift the scooter by the armrests, seat or tiller, harm could be done to the user or to the scooter.

#### 6.3 SEAT BACKREST RECLINE:

#### **⚠️WARNING!**

- Take care when adjusting the seat backrest recline angle as it could be possible to fall backwards and harm the user or the scooter.
- When adjusting the back angle, be careful not to get your fingers caught.

The seat backrest recline angle is adjusted by the lever shown in Fig 6.1.



#### 6.4 SEAT POSITION:

The scooter seat can be adjusted in a forward or backwards position. The adjustment lever is found on the right hand side under the front of the seat. Pull the lever upwards and use legs and body to move to the required position and release lever, (Fig.6.2).



Fig.6.2

**⚠ DANGER!**

Your scooter may have a factory fitted stop limiting the range of the movement of your seat, and must not be removed. The stop ensures your scooter remains stable when travelling on slopes.

**6.5 ARMREST ANGLE/DEPTH ADJUSTMENT:**

The scooter armrests are angle adjustable for user comfort. The adjustment bolt (1) is found under the armrest body. The bolt is rotated either way to increase or decrease the angle of the armrest, (Fig.6.3). The armrest depth is adjusted via the 2 bolts underneath the armrest pad.



Fig.6.3

**6.6 TILLER ADJUSTMENT:**

**⚠ DANGER!**

- Do not adjust the tiller while the scooter is being driven as serious injury could happen if you lose control.
- Do not use the tiller adjustment handle to hold or carry items such as bags etc.
- Ensure fingers or other items are not around the area of the lower tiller when making adjustments. Serious injury could happen due to entrapment.

The angle of the tiller can be adjusted for getting on and off the scooter and for achieving a comfortable driving position.

1. Pull and hold the lever upwards.
2. Hold the handlebar and push or pull the tiller to the required position.
3. Let the lever go.

The tiller contains a gas strut to aid in the adjustment of the tiller position, (Fig.6.4).

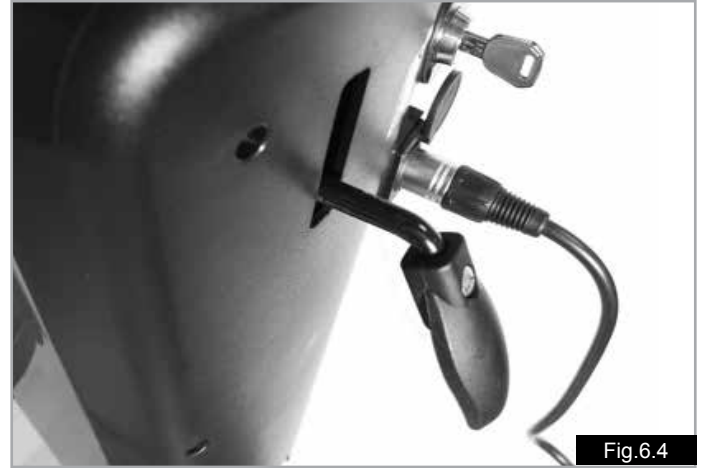

Fig.6.4

**6.7 SLOPES:**

Please also refer to section 4.20. The following instructions explain how to manoeuvre correctly on steep ramps and slopes, especially in the course of descent, (Fig 6.5, next page).

**⚠ DANGER!**

- Low speed settings are recommended when traveling on slopes, particularly in reverse.
- We strongly recommend that you bring the seating backrest into an upright position during manoeuvres on slopes.
- If you stop on an incline, start off slowly and, if necessary, lean forward to counteract the tendency of the front wheel to rise.
- On descents it is important not to allow the scooter to exceed normal speed. Indeed, the safest course is to go down steep hills slowly and to stop immediately if you have any doubts about the steering.
- Do not attempt inclines when any of the following accessories are fitted, rear storage bag, rear mounted wheelchair/walker holder or oxygen bottle holder, as they may cause the scooter to become unstable.

## DANGER!

- If the scooter gathers speed, release the control lever to slow down, or stop completely.
- Start off again slowly and do not allow speed to increase.
- Make sure the scooter is in drive mode as this ensures that the automatic braking system is active.
- Climbing or descending a slope with the automatic brakes disengaged is very dangerous and is not recommended.
- Always reduce your speed when turning corners, particularly when travelling down slopes.
- Disregarding this advice could lead to your Scooter tipping over.
- Do not traverse across the face of a slope in excess of 10° - 1 in 6, (S700) or 8° - 1 in 7, (S400-S425).
- Disregarding this advice could result in your Scooter tipping.

### 6.8 SLOPE CLIMBING

(Fig 6.5).

- Where possible always travel up slopes or ramps directly facing the slope of the hill.
- When driving up or down a very long hill, it is a good idea to rest for a moment to break the journey up. This will aid performance and allow the scooter motor to cool down.
- Do not traverse across the face of a slope in excess of 10° - 1 in 6, (S700) or 8° - 1 in 7, (S400-S425).
- Always reduce your speed to the minimum setting when reversing down hills.
- Do not attempt to drive along with the wheels at different levels, e.g. along the footpath and road simultaneously.

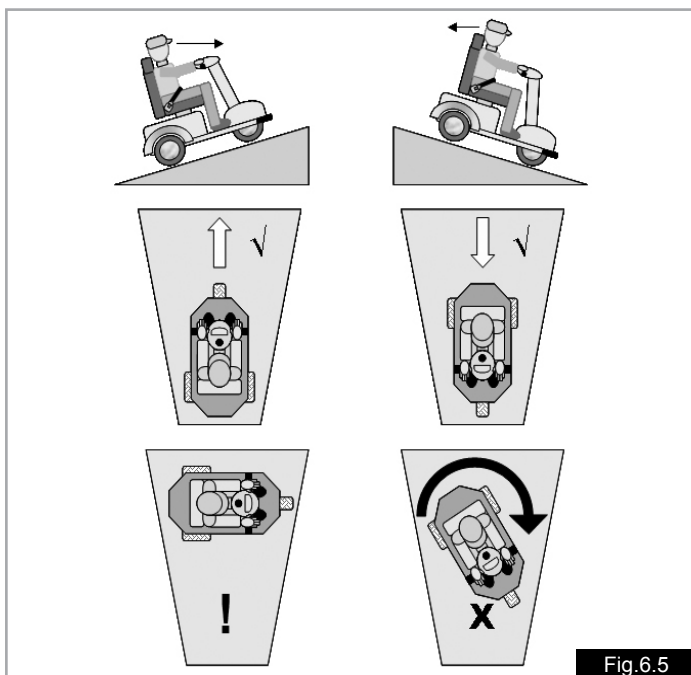

### 6.9 FREE-WHEEL DEVICE:

## DANGER!

Please also refer to section 4.7

- Do not sit on the scooter when free-wheel mode is activated.
- Do not attempt to drive the scooter when free-wheel mode is active.
- Never allow the scooter to be pushed in free-wheel mode by other persons when you are still on board.
- Do not activate free-wheel mode when the scooter is stopped or parked on a significant slope.
- Never attempt to activate free-wheel mode whilst you are still on board the scooter.

Push the red button down and push the lever forward in the free-wheel position. If you wish to push the scooter with the motors off, you should follow this procedure. When the levers are pushed backwards, the drive wheels will automatically connect with the propulsion mechanism and the red button will return to its locked position. (Fig.6.6).

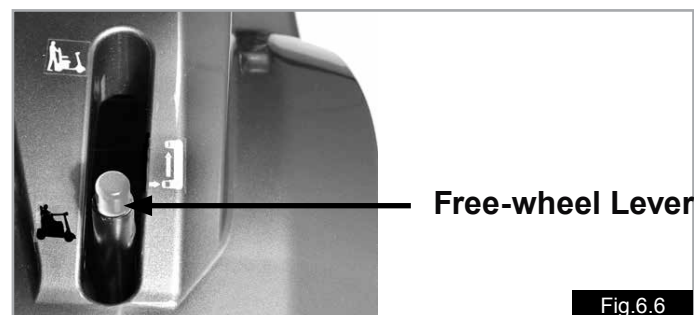

### 6.10. TYRE PRESSURE:

It is important to check inflation pressure regularly, along with the state of wear of the tyres. The maximum pressure recommended for the wheels should be up to :  
S700 = 2.7 bar (40 P.S.I.)  
S425, S400 = 2.7 bar (40 P.S.I.)  
For further information on tyres please refer to section 18.2 and 18.3.

## DANGER!

Never inflate the tyres with a service station air pump. It is recommended that you use a manual pump or a pump fitted with a pressure regulator (manometer).

### 6.11 MOUNTING A KERB OR STEP:

The Scooter is capable of mounting and dismounting kerbs and obstacles up to 50mm (2"), for the S400-S425 and 100mm (4") for the S700. Remember when climbing kerbs to drive forwards and face the kerb at 90°, (Fig.6.7).

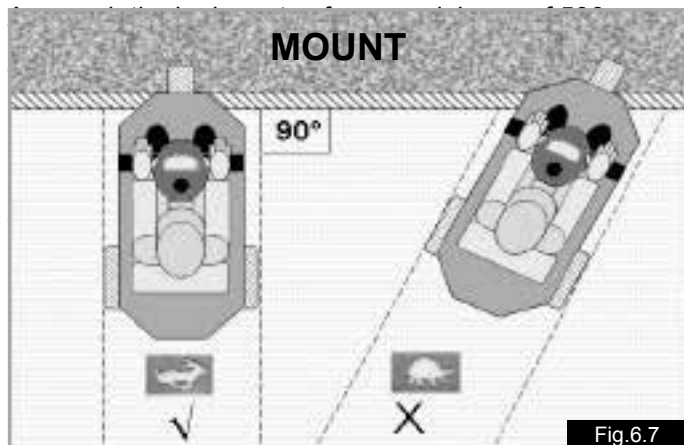

### 6.12 DISMOUNTING A KERB OR STEP:

To dismount a kerb, face the kerb at 90°, but select a low speed setting. Move forward and slowly allow your Scooter to drop gently, front wheel(s) first from the kerb. The rear stabilising wheels may make contact with the kerb when dismounting this is normal, (Fig.6.8).

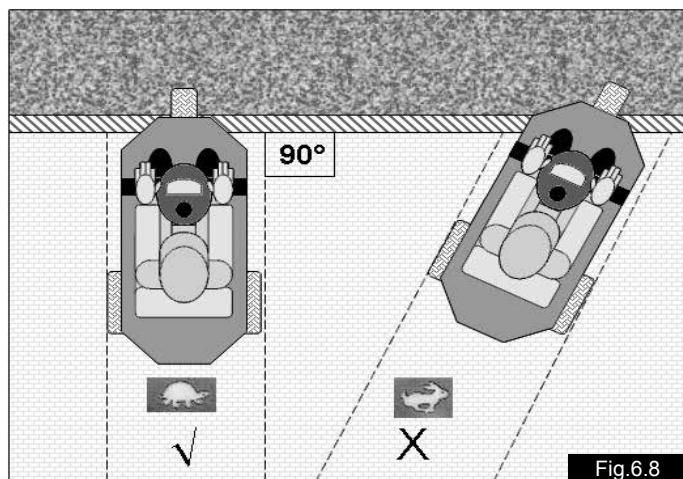

### 6.13 USING NEAR WATER:

Take extra care when using your scooter near open water. Canal tow paths, beaches, quay sides and river banks can be hazardous.

#### DANGER!

- Do not travel along a sloping surface leading to an open waters edge.
- Keep a distance of at least one scooter length from an open waters edge whenever possible.
- Beware of hidden obstacles such as tree roots drain covers and mooring rings as these may cause loss of control if you hit them unexpectedly.
- Use a low speed setting.
- Never reverse towards open water.
- Do not drive up or down steep slopes located near an open waters edge.
- Give way to pedestrians on canal tow paths and footpaths.
- Sound the horn to let other people know you are there.
- Never try to manoeuvre around pedestrians if it takes you too close to the waters edge.
- Avoid deep sand, gravel, mud and wet grassy slopes.
- Take extra care on windy days as loose clothing such as capes or blankets can suddenly fly up and may foul the controls or temporarily block you view.
- Do not get close to open water during a storm.
- When stationary, switch the scooter OFF at the key.
- Observe all local by laws, rules and regulations.

#### CAUTION!

- Always clean your scooter thoroughly if it has been exposed to mud, sand, salt or other contaminants.
- Do not use a high pressure washer, (see section 11).

7.1 SCOOTER CONTROL CONSOLE

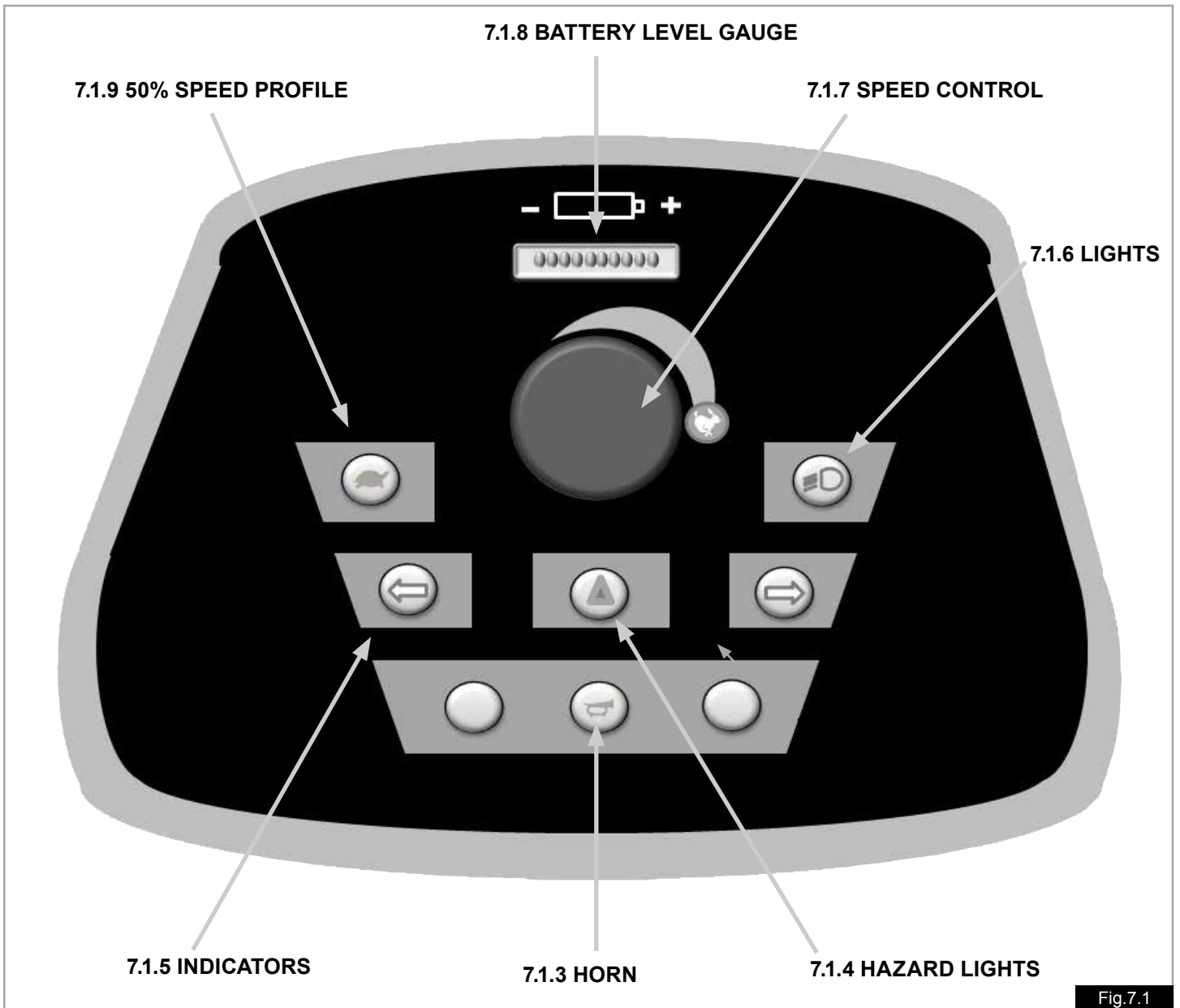
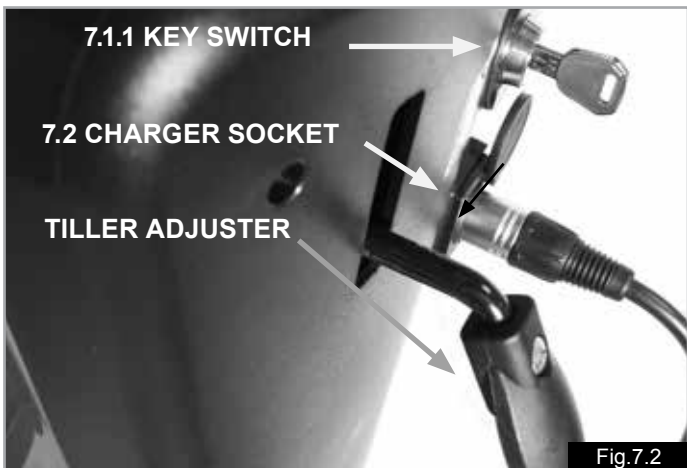

Fig.7.1





### 7.1.1 ON/OFF KEY SWITCH

The On/Off key switch applies power to the control system electronics, which in turn supply power to the scooter motor.

- To turn ON Insert the key vertically and turn 90 degree clockwise.
- To turn OFF scooter, turn key back to vertical position and remove, (Fig.7.2).

#### **WARNING!**

- Do not use the on/off key switch to stop the scooter unless there is an emergency. (If you do you may shorten the life of the scooter drive components).
- To avoid unexpected or unintentional movement of the scooter and to conserve battery power, it is recommended that the key switch is switched Off when stationary or not being used.

### 7.1.2 CONTROL LEVER (WIG-WAG)

Located by handle bar grips. Your speed and forward and reverse motion is controlled via the wig wag.

Gently pull with the right hand or push with the left thumb to move the scooter in a forward motion. The amount of movement applied to the wigwag also proportionally controls the speed of the scooter.

The left hand or right thumb moves the scooter in a reverse motion and also controls the speed of the scooter in reverse.

The lever will return by itself when released, and you will stop gently. Braking is engaged when the Wig-Wag is released, (Fig.7.3).

#### **WARNING!**

The factory default setting is described above. Be aware that it is possible the throttle operation could be reversed through programming, particularly if you are a second user.

When stopping the high visibility rear LED braking lights will illuminate. These also function when the scooter lights are turned on.

**NOTE:** Forward and reverse functions can be swapped over from right hand operation to left hand operation, via programming. Please consult your authorised Sunrise dealer.

#### **WARNING!**

It is important that you stop the scooter before you change direction from forward to reverse.

Always turn the scooter control system off via the key switch before you transfer in or out of the scooter.

### 7.1.3 HORN

The horn will sound while this button is depressed.

### 7.1.4 HAZARD LIGHTS

With the scooter ON the front and rear LED indicators will flash simultaneously when this button is pressed.

The visual indicators on the direction buttons on the keypads will also illuminate.

Press the button again to switch the hazard lights off.

### 7.1.5 INDICATORS

Pressing the button will illuminate the front and rear LED indicators in a flashing pattern indicating you are turning the scooter. On the keypad the visual indicator LED will flash, also the front indicator pods have a special extended lens that can be seen from most driving positions.

To turn off the indicators press the button again.

### 7.1.6 LIGHTS

Pressing the button will turn on the front LED headlight, and the rear LED lights

**NOTE:** If the lights are inadvertently left on after use, removing the ON/OFF key will extinguish the lights automatically.

#### **WARNING!**

Ensure that the lights and indicators are functioning correctly and all of the lenses are clean, before using the scooter at night or during poor visibility.

### 7.1.7 SPEED CONTROL

This allows you to pre-set your desired scooter speed. Turn the dial anti-clockwise to slow for very gentle operation. Turn it clockwise to increase your speed to maximum

Remember that only with practice will you become a competent driver. Find a safe, hazard free environment to practice controlling the scooter and familiarise yourself with the controls and functions.

#### **WARNING!**

For the safety of the operator and other pedestrians, Sunrise Medical recommends that whilst driving on footpaths and other pedestrian walk ways, the scooter pre-set speed should be set to less than 4 mph/6kph.

### 7.1.8 Battery Level:

This indicates the average amount of charge you have in the batteries. Green indicates fully charged batteries with reducing charge to the red indicator. Red indicates warning and less than half-charged batteries, (7.1.9). Please be aware that the meter reading will fluctuate when accelerating from start or traveling uphill, this is normal. The reading is more accurate when the scooter is operating on flat level ground.

#### 7.1.9 50% Speed Profile: (Tortoise Button)

This button, changes the speed of the scooter to a pre-set 50% of maximum speed and reduces the acceleration and deceleration.

This is ideal when travelling indoor or within confined spaces.

To return to normal driving, press the button again, (Fig.7.2.4).

When this mode is active, the scooter speed can also be reduced further by using the speed control dial.

### 7.2 CHARGING SOCKET:

#### **WARNING!**

The charging socket should only be used for connecting the scooter battery charger plug to the scooter.

The charging socket should not be used to supply power for any other device.

Connection of unapproved electrical devices may damage the control system or compromise the EMC performance of the scooter.

Always put the socket cover back over the charging socket when the battery charger plug has been removed, (Fig. 7.4).

Please see section 9.0 for more details about charging.

### 7.3 PROGRAMMING:

When the scooter leaves the factory, the parameters of the controller are set to accommodate most driving styles and preferences. However the scooter control system is very versatile and will allow certain functions to be reprogrammed.

If required, the programming socket, (located in the main controller), will enable an approved Sunrise Medical authorised dealer to reprogramme your scooter.

Your approved Sunrise Medical authorised dealer can also gain useful service information via the programming socket, from the scooter's on board diagnostics facility.

To programme the controller a special programming device is required, (hand-held or PC software), which is only available to your Sunrise Medical authorised dealer.

#### **DANGER!**

- Programming the scooter is only allowed via authorised personnel trained by Sunrise Medical.
- Incorrect controller settings could cause driving outside the safe limits and could result in damage or injury.

**NOTE:** Sunrise Medical does not accept responsibility for damages / injuries which result from unexpected movement or stopping of the scooter due to inappropriate programming or unauthorised use of the scooter.



Fig.7.4

## 7.4 OPERATING THE CONTROLS:

If you are new to driving a scooter, it is a good idea to practice in a clear, safe space on a sound level surface. Put the key in its slot, but do not turn the scooter on. Board the scooter by following the instructions in section 4.16.

## 7.5 BASIC DRIVING TECHNIQUES:

Make sure you are properly seated and can comfortably reach all the controls on the scooter.

1. Set the speed control to its lowest speed.
2. Turn the key clockwise (90 degrees) to turn the scooter on.
3. On the tiller, gently operate the Wig-Wag as described earlier, (7.3). You will gently accelerate. Release and you will gently stop. Practice these two basic functions until you get used to them.
4. Steering the scooter is easy and logical. Just be sure to remember to get wide clearance when turning so that the rear wheels clear any obstacle.
5. Short-cutting a pavement corner can cause the back wheel to go off the pavement, causing problems, if the corner is very rough. Avoid this at all times by steering an exaggerated curve around the obstacle.
6. When steering in a tight spot, such as entering a doorway or when turning around, stop the scooter and then turn the handlebar to where you want to go, then apply power gently. This will make the scooter turn tightly. It is also recommended that the pre-set speed is set to a slower setting to aid control in tight spots.

### DANGER!

Reversing requires extra attention as the field of vision is restricted.

**NOTE:** Using the right thumb or left fingers to operate the Wig-Wag will reverse the scooter.

### DANGER!

It is advisable that during the first few **sessions** of operating your scooter that the area around you is clear of obstacles and pedestrians.

Before operating your Scooter, ensure the seat height has been adjusted to your satisfaction, and the tiller angle has been set for optimum safety and comfort.

### DANGER!

- When using your Scooter on public walk ways and footpaths, always be aware of pedestrians and situations which might require extra care.
- Be especially vigilant around young children and pets.
- Remember, when driving in public places drive with caution and regard for others at all times.
- When manoeuvring in confined areas, including shops, ensure the minimum speed is selected.
- If you leave your Scooter unattended, ensure that it does not obstruct pedestrians or other road users.
- Remember to keep the key with you at all times for your safety and security.
- For the safety of the operator and other pedestrians, Sunrise Medical recommends that whilst driving on footpaths and other pedestrian walk ways, the scooter preset speed should be set to less than 4 mph/6kph.

## 7.6 BRAKING:

To stop the Scooter simply release the Wig-Wag, whilst keeping your hands on the handlebar. Two types of braking will automatically operate in sequence:

- Automatic regenerative braking, which slows the Scooter to a standstill.
- Automatic parking brake which will operate as the scooter comes to a stop. The automatic parking break holds the Scooter in position, even if you are on a hill.

**NOTE:** This is a two stage process and is not instantaneous. First the scooter slows down and stops, then the parking brake comes on. When starting off again the parking brake will release automatically. If the throttle is momentarily engaged and released, the parking break will release and then engage again in approximately 1/2 a wheel turn.

## 7.7 SECONDARY PARKING BRAKE

(Fig.7.5).

Your scooter is fitted with a secondary parking brake. If the free-wheel position is engaged the secondary parking brake can be operated by pulling the hand brake lever, (A), on the left hand side of the tiller. This engages the secondary brake on the rear wheels to prevent unintentional movement whilst in free-wheel mode, (drive disengaged).

Before attempting to push the scooter in free-wheel mode, release the secondary parking brake by pulling back the small thumb lever, (B).

### DANGER!

- After completing any manoeuvres in free-wheel mode, always re-engage drive mode by moving the free-wheel lever to the drive position.
- Do not use the secondary parking brake to slow the scooter down during the normal driving process.

## 7.8 EMERGENCY BRAKING - KEY SWITCH

In the unlikely event of an unwanted movement of the Scooter, turning the key switch OFF will cause the Scooter to come to an immediate stop. Though very effective, emergency braking is extremely abrupt and must never be used in normal use.

## 7.9 SWITCHING OFF

The Scooter must always be switched off at the On/Off key switch.

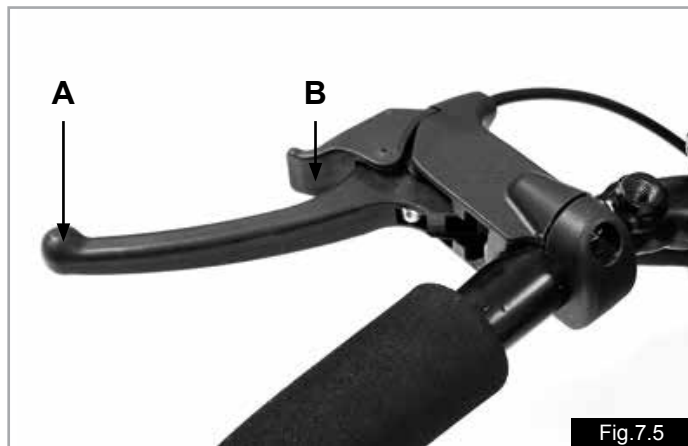

## 8.0 Troubleshooting - Display

### 8.1 BATTERY DISPLAY GUIDE:

(Fig.7.6).

Always consult your Sunrise Medical authorised dealer when a diagnostic fault has appeared on your scooter display.

The battery gauge indicates the status of the control system as well as the charge remaining in your batteries.

#### **Battery Gauge is steady:**

This indicates that everything is OK and the display is showing the battery charge level.

**NOTE:** The number of LED lights will vary under different load conditions such as going uphill etc. This is normal. More accurate readings are obtained when travelling on flat, level surfaces.

#### **Battery Gauge flashes One or more LED lights:**

**Scooter Fault-** The LED battery gauge displays the fault as a series of flashing LED's.

The flashing LED's indicate the control system safety circuits have operated and the control system has been prevented from moving the scooter.

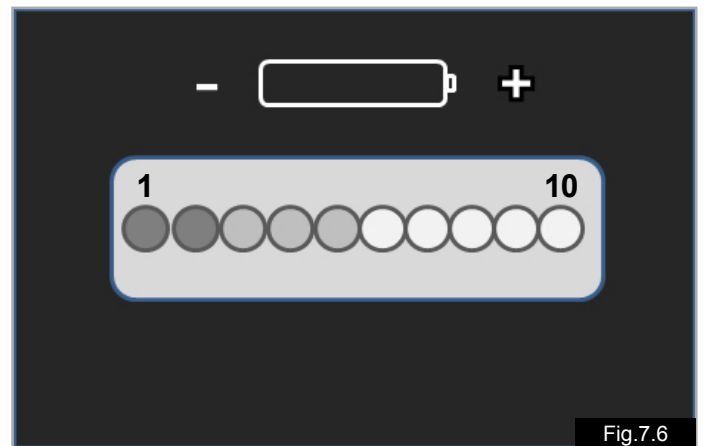

## 8.2 SELF HELP GUIDE:

NUMBER OF LED'S FLASHING	POSSIBLE CAUSE	SOLUTION
2	Low battery voltage	The battery needs charging or there is a bad connection on the battery. Check the connections to the battery. If the connections are good, try charging the battery.
3	High battery voltage	An excessive voltage has been applied to the system. This is usually caused by a poor battery connection. Check the battery connections. Check that you are using the charger supplied with your scooter or an approved replacement.
5	Solenoid brake trip	The motor brake has a bad connection. Check the motor brake and motor connections. Make sure all the system connections are secure.
6	Throttle trip	A throttle trip is indicated. Make sure that the throttle is in the neutral position before switching on the scooter.
7	Throttle trip	A throttle trip is indicated. Make sure that the throttle is in the neutral position before switching on the scooter.
8	Motor disconnected	The motor has a bad connection. Check all the connections and leads between the motor and power module. Check the position of the free-wheel lever.
9	Possible Controller Trip	Check all plugs and sockets.
10 + Beep	Free-wheel Activated	The free-wheel lever is activated and the motor brake disengagement mechanism is operated. Check the position of the free-wheel lever and select DRIVE. Switch off and back on again to clear the fault.

### What to do next?

- Switch the scooter off.
- Check that none of the plugs and sockets have become loose or disconnected.
- Check the condition of the battery and charge them if necessary.
- If you can't find the problem, try the self help guide above.
- Switch the scooter on again and try to drive the scooter.

### WARNING!

- If the safety circuits continue to operate, switch off and do not try to use the scooter.
- Contact your Sunrise Medical authorised dealer.

### Other Drive Faults:

#### Slow or sluggish movement:

If the scooter does not travel at full speed or does not respond quickly enough and the battery condition is good, check the maximum speed setting.

If adjusting the speed setting does not remedy the problem then there may be a non hazardous fault.

#### No Drive:

Charger Connected?

The system is being inhibited from driving. This may be because the battery charger is connected. Disconnect the charger.

Consult your Sunrise Medical authorised dealer.

## 9.0 Batteries and Charging

### **WARNING!**

 Please read the owner's manual supplied with the charger carefully. The general procedures and effects for the interference with the scooter and the batteries remain valid.

- Do not smoke near batteries.
- Do not expose any part of the battery to direct heat (i.e. naked flame, gas fire).
- When charging always place your charger on a hard surface in a room with good ventilation.
- You should not charge your batteries in outdoor conditions.

### 9.1. BATTERY & CHARGER SPECIFICATION:

#### **Batteries:**

S400 = 24 V (2x12 V) / 38 Ah.,AMG Type-maintenance-free

S425 = 24 V (2x12 V) / 55 Ah.,AMG Type-maintenance-free

S700 = 24 V (2x12 V) / 75 Ah.,AMG Type-maintenance-free

#### **Dimensions:**

Please see Technical Specifications.

**NOTE:** Optional batteries with different capacities are available.

#### **Dimensions:**

Please see Technical Specifications.

#### **Charger:**

Connector: 3 pin "Neutrik" type

Charger: 24V d.c. 8 A Cyclic, (S700-S425).

24V d.c. 5 A Cyclic, (S400).

### **WARNING!**

Only use the charger supplied with your scooter to charge the batteries fitted to your scooter.

### 9.2 ELECTRICAL FUSES:

To prevent the scooter from becoming overloaded, fuses been built into the battery looms. The fuses automatically isolate the battery from the scooter wiring and control systems in the event of an electrical short circuit.

If you suspect that the fuses have blown, contact your Sunrise Medical authorised dealer as soon as possible, who will carry out a full diagnostic to determine the cause of the original fault.

### **WARNING!**

- Do not attempt to change the fuses yourself.
- Do not attempt to by-pass the fuse as this would be very dangerous. If you suspect a fault, contact your Sunrise Medical authorised dealer as soon as possible.

### 9.3 BATTERIES

For all warnings and the detailed removal process please refer to section "5.3 Batteries", on pages 18 and 19.

### 9.4 GENERAL BATTERY INFORMATION

The design of batteries used in mobility products is significantly different to the batteries used to start a car for example.

Car batteries are designed to release a large amount of power over a short period of time, whilst mobility batteries (commonly called deep cycle batteries) release their power evenly, over a long period of time.

Commonly two 12 volt batteries are used together in a mobility product, giving a total voltage of 24 volts.

The size of the battery (e.g. its available power) is expressed in amps per hour e.g. 75 Ah. The higher the number, the bigger the battery size, weight and, potentially, the greater the distance you can travel. Sunrise Medical only fit as standard sealed maintenance-free mobility batteries into these types of scooters.

### 9.5 MAINTENANCE-FREE BATTERIES:

The batteries supplied with your scooter are AGM type batteries where the electrolyte is held in Absorbed Glass Matt and sealed in the battery case. As the name implies no maintenance is required other than regular charging. These are similar to “gel” type batteries. The batteries have not been tested for air transport and are not IATA approved.

### 9.6 BATTERY CARE:

Over the years, battery technology has moved forward but, unfortunately, some of the advice given on battery care has not.

This has resulted in a number of confused and at times contradictory instructions on the ‘best’ way to care for your batteries.

This section will help to dispel some of these myths and legends.

Below is set out a battery care plan for maintenance-free batteries. This has been agreed between Sunrise Medical and the battery manufacturers, to enable you to get the best out of your batteries. If a different care plan is followed, this may result in lower than expected performance from your mobility vehicle.

### 9.7 MAINTENANCE-FREE BATTERY CARE PLAN:

Only use an approved Sunrise Medical charger compatible with the vehicle to be charged.

- Charge your batteries every night, regardless of the amount of use your mobility device has had during the day.
- Do not interrupt the charging cycle.
- If your mobility device is not required for use, it should remain connected to the charger until required. This will not damage your batteries, as long as the mains socket/plug is left switched on. Turning the mains socket/plug off, but leaving the mains cable plugged in will eventually deplete your battery charge.
- If you leave your vehicle for an extended period (more than 1 week), charge the batteries fully and then disconnect the main battery lead. When the scooter is to be used again, charge the batteries for a further 24 hours before use.
- Failure to allow for recharge will damage the batteries and can lead to shortened distances and premature failure.
- Do not top up the charge of your batteries during the day. Wait until the evening for a full overnight charge.
- As a general rule, maintenance-free batteries take longer to fully charge than wet lead acid batteries.
- Charge the batteries for at least 8 hours to ensure a full charge.

- The battery terminals need to be checked regularly for signs of corrosion. If any corrosion is apparent, then clean the terminals completely (a wire brush is ideal) and re-grease the terminal using Vaseline petroleum jelly, not ordinary grease. Ensure that the terminal nut and bolt, cable clip and exposed cable are completely covered with jelly.
- Following all the points above should result in a healthier battery, greater range for the vehicle user and a longer life for your batteries.
- Spent batteries may be returned to Sunrise Medical, your Sunrise Medical Dealer or your local recycling depot equipped to dispose of batteries.

### 9.8 GENERAL CHARGER INFORMATION:

The external charger has been designed to charge two 12 V Gel type batteries connected in series (= 24 V).

### 9.9 CHARGER SPECIFICATION:

#### ⚠ WARNING!

Only use cyclic chargers designed for mobility batteries, Gel-Type, with a maximum output not exceeding 24V/10A.



For more information about the charger operation, consult the instructions provided with the charger.

**NOTE:** If the charger is not connected to the scooter, it does not output charge voltage.

#### ⚠ WARNING!

It is possible that the charger’s metallic box may slightly raise in temperature due to use.

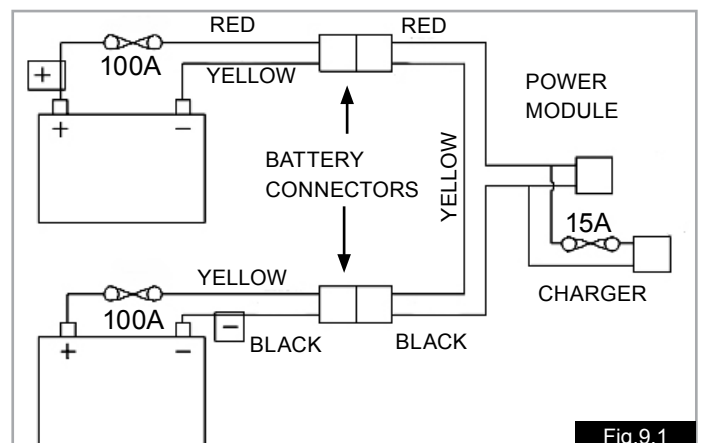

Fig.9.1

## 9.10 CHARGER SAFETY FEATURES:

The charger has features that prevent hazards or accidents occurring as a result of connecting batteries the wrong way round, overheating caused by fault conditions or attempting to charge wrong voltage batteries.

The 3 pin UK mains input plug contains a replaceable fuse. The rating of this fuse is shown on the charger label.

### ⚠️WARNING!

- Always replace fuses with the same type and size of fuse as specified.
- Fitting of different fuses can result in damage to the charger or failure of the charger to operate properly.
- If your charger has been specified for use in Continental Europe it will contain a European two pin plug which does not have a fuse. In this case the fuse is located inside the case or on the fascia panel of the charger.

## 9.11 PROCEDURE FOR CONNECTING THE CHARGER AND CHARGING:

The scooter can be charged via the charger socket on the rear of the tiller panel. Fig 9.2

- Ensure the scooter is switched off.
- First, connect the charger to the scooter.
- Then, connect the charger to the mains supply by means of the mains plug and switch on.
- The RED LED will illuminate to show that the power is ON, (Fig.9.3).
- The RED LED flashes to show a fault.
- The YELLOW LED will illuminate to show the batteries are charging, (Fig.9.3).
- The YELLOW LED flashes to show incorrect or no battery connected.
- The GREEN LED will illuminate when the charge cycle is complete, (Fig.9.3).

### ⚠️CAUTION!

- Do not leave the charger connected to the battery with the mains disconnected or switched off. This could result in damage to your battery being caused by deep discharge over a period of time.
- Always switch off at the mains before disconnecting the charger from the scooter.

### ⚠️WARNING!

- If the RED LED flashes, switch the charger off at the mains supply and contact your Sunrise Medical authorised dealer.

## 9.12 CHARGER SAFETY AND CAUTION NOTES:

### ⚠️WARNING!

- The charger is designed for indoor use. Do not use outdoors or expose to rain, snow, spray or moisture.
- When buying replacement batteries or charger always consult your Sunrise Medical service agent.
- To reduce the risk of damage to electric plug and cord, pull by the plug rather than the cord when disconnecting the charger.
- Make sure the cord is located so that it will not be stepped on, tripped over or otherwise subjected to damage or stress or cause a trip hazard.
- A mains extension cord should not be used unless absolutely necessary.
- Use of an improper extension cord could result in a risk of fire and electric shock.
- If any extension cord must be used, make sure the pins on the plug of the extension cord are the same number, size and shape as those of the plug on the charger and that the extension cord is properly wired and in good electrical condition.

**NOTE:** The scooter can remain safely on charge for a couple of weeks. When the Scooter is not to be use for a long period of time, first charge the batteries fully and then disconnect them from the scooter. Store as close to room temperature as is possible.



Fig.9.2



Fig.9.3



### 9.13 THE RANGE OF YOUR VEHICLE:

The range figures are calculated in accordance with international standard test, ISO 7176-part 4, Wheelchair Energy Consumption Theoretical Range.

This test is intended to provide a standard method by which different manufacturers can measure/calculate the range using the same test method and allow purchasers to make direct comparisons about the range of different scooter models.

This test is carried out in controlled conditions with new, fully charged batteries, on a level test surface and a user weight of 100 kg.

The theoretical maximum range is as follows:

S400 = 25 km

S425 = 25 km

S700 = 35 km

These values should be seen as a theoretical maximum and will be affected, (most likely reduced), if any single, or combination of factors listed in Section 9.15 occur:

### 9.14 THE MAXIMUM POTENTIAL RANGE OF YOUR VEHICLE:

Based on industry benchmark potential range figures for similar products and battery sizes, the maximum potential range of your vehicle is listed as below:

S400 – 36km

S425 – 42km

S700 – 55km

These values should be seen as a maximum potential range and will be affected, (most likely reduced), if any single, or combination of factors listed in Section 9.15 occur:

### 9.15 FACTORS THAT AFFECT THE POTENTIAL RANGE OF YOUR VEHICLE:

- User weight more or less than 100 kg.
- Batteries whose charge, age and condition is less than perfect.
- The terrain/surface is difficult e.g.. Very hilly, sloping, muddy, loose, rough or consisting of gravel, grass, or snow and ice.
- The scooter regularly climbs kerbs.
- The ambient temperature is very hot or very cold.
- Incorrect tyre pressures in one or more tyres.
- Lots of start/stop journeys.
- Use of additional powered options e.g. lights and indicators.

#### NOTE:

- The battery size used on each scooter, should provide sufficient range for the majority of user requirements.
- Enhanced driving techniques, such as avoiding kerbs and using paths instead of open ground, may assist in improving the available range.
- Correctly charging the batteries on a daily basis will also assist in improving range and battery life.

## 10.0 Adjustments

### ⚠ WARNING!

- Only undertake adjustments on your scooter if you are qualified to do so.
- Serious injury or damage can occur if adjustments are not carried out correctly.
- If you are unsure please contact your Sunrise Medical dealer for assistance.

### 10.1 SEAT HEIGHT ADJUSTMENT

- Remove the battery cover to access the seat height adjustment bolts.
- Remove the seat stem fixing bolt (Fig 10.1)
- The seat height can be adjusted to a range of 50mm.
- When the desired position is reached, replace the bolt through the seat stem hole and tighten to a torque of 25 Nm.



Fig.10.1

### 10.3 PROGRAMMING:

When the scooter leaves the factory, it is programmed to best suit the general needs of our customers. This is a generic or default programme. However, if any alterations are required, then you should contact your dealer, where a specialist can reprogramme the scooter to fine tune it to your needs.

**NOTE:** A programmer or a PC-based software program with the appropriate connecting lead are required to program the wheelchair.

### ⚠ DANGER!

- Never attempt to programme the scooter yourself.
- Programming the controller of the scooter is only allowed through authorised personnel trained by Sunrise Medical.
- Incorrect controller settings could cause a driving profile outside the safe limits and could result in damage or injury.

## 11.0 Cleaning

### 11.1 CLEANING GENERAL:

#### WARNING!

Ensure the controller is switched off before cleaning.

- The scooter should be wiped over once per week with a slightly damp, (not wet), cloth.
- Make sure that you dry all parts of your scooter if it becomes wet or damp after cleaning or if it is used in a wet or damp atmosphere.
- It is important that should the scooter be used by more than one person it is cleaned thoroughly to ensure there is no cross infection.
- You should use a proprietary disinfectant for this task. Please pay attention to the manufacturer's instructions of the disinfectant you are using.
- Inspect the upholstery/seating for tears, dents, wearing or slackening of upholstery particularly near to metal as this could result in poor posture or lower levels of comfort and pressure relief.

### 11.2 CLEANING SEATING:

All parts/accessories such as crutch holders should be cleaned with a damp cloth.

The headrest, armrests, lap belts should be cleaned with a damp cloth.

#### CAUTION!

Do not use a hose or a pressure or steam washer to clean your scooter.

### 11.3 CLEANING CONTROL SYSTEM:

Clean the control system and the keypad with a cloth dampened with diluted detergent. Be careful not to use excessive water or force when cleaning the control keypad.

#### CAUTION

Never use abrasive or spirit based inflammable cleaners.

## 12.0 Shipping and Storage

### 12.1 STORAGE TEMPERATURE & HUMIDITY:

Storage Temperature: Min: -40°C Max: 65°C

Relative Humidity ( non-condensing): Min:5% Max: 95%

#### CAUTION!

- Before you travel, please contact the appropriate carrier.
- The travel operator will be able to supply details of any special requirements/instructions.

### 12.2 USING YOUR SCOOTER ON THE TRAIN:

If you wish to use your scooter on the train, we recommend that you contact the train operator in advance when planning your journey. Railway carriages have provision for a "wheelchair" space where you can sit on your scooter during the journey. Please note that the overall length of your scooter may be greater than the available length of the "wheelchair" space in the railway carriage.

When planning your journey, you should check with the train operator that there will be suitable boarding access available to allow you to access the railway carriage and the intended "wheelchair" space on joining and leaving the train and there is suitable access onto the platform. We recommend you check with the train operator that ; the boarding access is suitable for the combined mass of your scooter and the occupant; the slope of the access is not greater than the maximum safe slope of the scooter; any steps or risers are no greater than the maximum height of the scooter obstacle climbing height; there is adequate turning space within the access area to the train and on the train.

Most train operators will provide assistance provided that arrangements have been made in advance. We suggest you have you Owner's Manual ready when planning your journey and contacted them.

### 12.3 OTHER TRANSPORT REQUIREMENTS:

The scooter may be transported by road, rail, sea or air as luggage.

Before you travel, please contact the appropriate carrier or travel operator. You may be asked to provide certain information about the scooter such as the scooter mass and overall dimensions. This information can be found in the relevant model tables in section 15.1.

If the scooter is transported by air, the batteries may need to be removed as the batteries supplied are not IATA approved for air travel. Your dealer can assist in supplying batteries that are IATA approved.

If transporting the scooter by road as luggage, it may need to be secured to prevent unintended movement into other vehicle passengers in the event of a sudden stop or placed in a space reserved for luggage. Your scooter can be secured by attaching suitable restraints to the front and rear bumpers as shown on the figure below.

#### WARNING!

Do not sit in your scooter when it is transported as luggage.



## 12.4 REMOVAL OF PARTS BEFORE TRAVELLING:

Information on the removal of some parts before travelling, should your travel operator or the carrier require to do this can be found in this manual, which you should take with you, as follows;

How to remove the seat; Section 5.1 (page 14)

How to disconnect and remove the batteries; Section 5.3 (page 16)

How to disconnect the drive; Section 4.7, (page 9)

You should also ensure that any detachable parts e.g. basket, crutches etc. are secured with your scooter or separately packed and labelled so they do not get lost during loading or unloading.

## 12.5 USING A HOIST TO LIFT YOUR SCOOTER:

Your scooter WITHOUT OCCUPANT can be lifted using two suitably rated straps. An "H" frame constructed of a minimum of 4"x 4" timber sections should be used.

### ⚠ CAUTION!

1. The approximate maximum mass of the largest scooter S700 is 150Kg so each strap should be rated to 150kg. The hoist and "H" frame, should also be capable of lifting the maximum mass of the scooter.
2. The scooter should be switched off before hoisting and the keys removed.
3. The straps must be located as shown in Fig.12.1 and 12.2 below. DO NOT attempt to lift the scooter using any other points such as the seat or tiller.
4. Ensure the straps are the same length and are placed evenly so that the scooter is lifted evenly.
5. Never attempt to lift the scooter with an occupant seated.

Fig.12.1



Fig.12.2

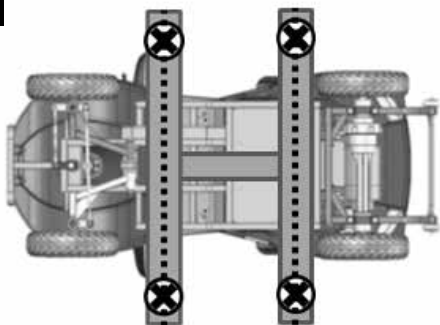

6. Place the front strap along the length of the front "H" frame strut, ensuring the strap has even lengths either side.
7. Repeat the process for the rear "H" frame strut, ensuring the straps have equal lengths.
8. Attach the straps to the hoist and follow the hoist manufacturer's instruction to raise and lower the scooter to the desired position.
9. Remove the straps and replace the keys on completion of the manoeuvre.

### ⚠ WARNING!

Never lift/hoist the scooter with the occupant sitting in the seat.

### Relevant sections in this Owner's Manual:

- Ensure that any detachable parts are secured with your scooter or separately packed and labelled so they do not get lost during loading and unloading.
- Take this Owner's Manual with you.
- The carrier will need to refer to the following sections.
- How to remove the seat, (Section 5.1, Page 14).
- How to disconnect the batteries, (Section 5.3, Page 16).
- How to disconnect the drive, (Section 4.7, Page 9).

## 12.6 MEDIUM TO LONG TERM STORAGE:

When storing your scooter for long periods of time (in excess of one week), follow these simple instructions: Fully charge the wheelchair for at least 24 hours. Disconnect the batteries

### ⚠ CAUTION!

Never store your scooter for medium to long periods of time:

- Outside.
- In direct sunlight, (plastic parts may discolour).
- Near a source of direct heat.
- In a damp environment.
- In a cold environment.
- With the batteries connected, (even if the controller is switched off).

Avoiding all of the above will minimise battery deep cycle discharge and extend battery lifetime.

When returning the scooter to use, please reconnect the batteries/battery boxes and charge the scooter for at least 24 hours before using again.

## 12.7 WEIGHT OF DETACHABLE PARTS

PART	WEIGHT kg
SEAT	35
FRONT BASKET	0.9
BATTERY BOX LID	1.1
ARMREST	1.0
HEAD REST	0.7

### 13.0 Disposal

The symbols below, mean that in accordance with local laws and regulations your product should be disposed of separately from household waste.

When this product reaches the end of its life, take it to the local collection point designated by local authorities. The separate collection and recycling of your product at the time of disposal will help conserve natural resources and ensure that it is recycled in a manner that protects the environment.

**NOTE:** Ensure you are the legal owner of the product prior to arranging for the product disposal in accordance with the above.

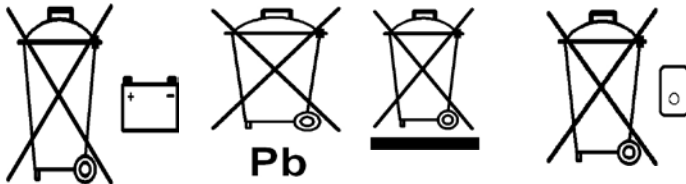

### 14.0 Torque Settings

#### ⚠ WARNING!

- Do not attempt to dismantle and/or reassemble the scooter on an engineering level, or fit any replacement parts or accessories if you are not qualified/authorised to do so.
- Always consult your approved Sunrise Medical servicing agent.

The torque information supplied below will enable normal routine maintenance tasks to be performed, (please also see section 18).

GENERAL TORQUE SETTINGS	
DESCRIPTION	TORQUE VALUE
M3 POZI PAN	2-3 Nm
M4 POZI PAN	3-4 Nm
M5 SKT HD CAP	4-5 Nm
M5 POZI PAN	4-5 Nm
M6 HEX HD	9-10 Nm
M6 BUTT HD	9-10 Nm
M6 SKT HD CAP	9-10 Nm
M8 HEX HD	15-20 Nm
M8 SKT HD CAP	15-20 Nm
M8 SKT BUTT HD	15-20 Nm
M10 HEX HD	20-25 Nm
M10 SKT BTT HD	20-25 Nm
SPECIFIC TORQUE SETTINGS	
Front Wheel Axle Bolt	32-Nm
Rear Wheel Hub Studs	25Nm
Seat Stem Height Bolts	20 Nm

### 15.0 Specification Sheets (EN 12184 & ISO 7176-15)

Sunrise Medical  
Thorns Road  
Brierley Hill  
West Midlands  
DY5 2LD  
England  
Phone: 0845 605 66 88  
Fax: 0845 605 66 89  
www.SunriseMedical.co.uk

**Operating temp:** -25°C to 50°C

**Storage temp:** -40°C to 65°C

**Moisture resistance:** IPX4

**No restrictions on humidity and air pressure.**

**Maximum occupant mass:**

**S400 = 136 kg, S425 = 150 kg, S700 = 160 kg**

The Sterling S-series scooters conform to the following standards:

- requirements and test methods for static, impact and fatigue strengths (ISO 7176-8)
- power and control systems for electric wheelchairs requirements and test methods (ISO 7176-14)
- climatic test in accordance with ISO 7176-9
- requirements for resistance to ignition in accordance with ISO 7176-16
- the product is specified as a Class B, (S400-S425), Class C, (S700), power product
- all materials used on this product conform to EN1021 parts 1 and 2

#### NOTE:

- See charts on following pages.
- Measurements of upholstered parts are approximate. All other measurements may be subject to change.

#### ⚠ CAUTION!

This scooter has not been tested to ISO 7176-19 for use as a seat when travelling in a vehicle.

**15.1 MODEL: STERLING S400**

<b>ISO 7176-15</b>	<b>MIN.</b>	<b>MAX.</b>	<b>COMMENTS</b>
OVERALL LENGTH	1345mm	1345mm	STANDARD CONFIGURATION
OVERALL WIDTH	645mm	645mm	STANDARD CONFIGURATION
TOTAL MASS (WITH BATTERIES)	108.5kg	108.5kg	STANDARD CONFIGURATION
MASS OF THE HEAVIEST PART	-	35kg	SEAT
STATIC STABILITY DOWNHILL	-	8°	136KG USER
STATIC STABILITY UPHILL	-	8°	136KG USER
STATIC STABILITY SIDEWAYS	-	8°	136KG USER
ENERGY CONSUMPTION (MAX. RANGE)	-	25 km	TO ISO 7176-4 (SEE SECTION 9.13)
DYNAMIC STABILITY UPHILL	-	8°-18%	136KG USER
OBSTACLE CLIMBING	-	50mm	STANDARD CONFIGURATION
RAMP TRANSITION	8°	8°	WITHOUT HIGH CENTRING
MAX. SPEED FORWARD		6 kph/ 4 mph	STANDARD CONFIGURATION
MIN. BRAKE DISTANCE FROM MAX. SPEED	-	4m	WITH STANDARD PROGRAMMING
MAX. SPEED REVERSE	-	50%	% OF FORWARDS SPEED
EFFECTIVE SEAT DEPTH		460mm	STANDARD CONFIGURATION
EFFECTIVE SEAT WIDTH		460mm	STANDARD CONFIGURATION
SEAT SURFACE HEIGHT	447mm	497mm	TO SCOOTER FLOOR (3 POSITIONS)
BACK REST ANGLE	-70°	60°	FROM VERTICAL
BACK REST HEIGHT		525mm	STANDARD CONFIGURATION
FORE / AFT SEAT ADJUSTMENT		+100mm	FROM REAR MOST POSITION
SEAT WEIGHT WITH SLIDE		35kg	STANDARD CONFIGURATION
TOP OF ARM REST TO SEAT		230mm	ARM REST SET AT 90°
MIN. TURNING RADIUS		3.03m	STANDARD CONFIGURATION
MIN. TURN BETWEEN WALLS		1.98m	STANDARD CONFIGURATION
NOMINAL BATTERY VOLTAGE	24V	24V	TWO 12V BATTERIES
REVERSING WIDTH	1.98m		
<b>ADDITIONAL SPECIFICATIONS</b>	<b>MIN.</b>	<b>MAX.</b>	<b>COMMENTS</b>
MAXIMUM POTENTIAL RANGE		36 KM	INDUSTRY BENCHMARK (SECTION 9.15)
CONTROLLER CUT-OFF VOLTAGE	16V		DRIVE STOPS
BATTERY CAPACITY		38Ah	SEE OPTIONS
BATTERY FUSIBLE LINKS	-	100A	IN-LINE FUSE ON EACH BATTERY
BATTERY CHARGER LOOM FUSIBLE LINK	-	15A	
BATTERY CHARGER	5A	5A	AUTOMATIC CYCLIC
MAX. KERB HEIGHT		50mm	
GROUND CLEARANCE		45mm	
REAR SUSPENSION TRAVEL		11mm	UNLADEN
FRONT SUSPENSION TRAVEL		23mm	UNLADEN
REAR WHEEL DRIVE	-	-	4 WHEEL SCOOTER
SCOOTER PUSH FORCE		100N	IN FREE-WHEEL
CRASH TESTED		NO	
TYRE PRESSURE		40psi	

## 15.2 MODEL: STERLING S425



ISO 7176-15	MIN.	MAX.	COMMENTS
OVERALL LENGTH	1345mm	1345mm	STANDARD CONFIGURATION
OVERALL WIDTH	655mm	655mm	STANDARD CONFIGURATION
TOTAL MASS (WITH BATTERIES)	117kg	117kg	STANDARD CONFIGURATION
MASS OF THE HEAVIEST PART	-	35kg	SEAT
STATIC STABILITY DOWNHILL	-	8°	150KG USER
STATIC STABILITY UPHILL	-	8°	150KG USER
STATIC STABILITY SIDEWAYS	-	8°	150KG USER
ENERGY CONSUMPTION (MAX. RANGE)	-	25 km	TO ISO 7176-4 (SEE SECTION 9.13)
DYNAMIC STABILITY UPHILL	-	8°-18%	150KG USER
OBSTACLE CLIMBING	-	50mm	STANDARD CONFIGURATION
RAMP TRANSITION	8°	8°	WITHOUT HIGH CENTRING
MAX. SPEED FORWARD		12 kph/ 8 mph	STANDARD CONFIGURATION
MIN. BRAKE DISTANCE FROM MAX. SPEED	-	4m	WITH STANDARD PROGRAMMING
MAX. SPEED REVERSE	-	50%	% OF FORWARDS SPEED
EFFECTIVE SEAT DEPTH		490mm	STANDARD CONFIGURATION
EFFECTIVE SEAT WIDTH		490mm	STANDARD CONFIGURATION
SEAT SURFACE HEIGHT	447mm	497mm	TO SCOOTER FLOOR (3 POSITIONS)
BACK REST ANGLE	-70°	60°	FROM VERTICAL
BACK REST HEIGHT		525mm	STANDARD CONFIGURATION
FORE / AFT SEAT ADJUSTMENT		+100mm	FROM REAR MOST POSITION
SEAT WEIGHT WITH SLIDE		35kg	STANDARD CONFIGURATION
TOP OF ARM REST TO SEAT		230mm	ARM REST SET AT 90°
MIN. TURNING RADIUS		3.03m	STANDARD CONFIGURATION
MIN. TURN BETWEEN WALLS		1.98m	STANDARD CONFIGURATION
NOMINAL BATTERY VOLTAGE	24V	24V	TWO 12V BATTERIES
REVERSING WIDTH	1.98m		
<b>ADDITIONAL SPECIFICATIONS</b>	<b>MIN.</b>	<b>MAX.</b>	<b>COMMENTS</b>
MAXIMUM POTENTIAL RANGE		42 km	INDUSTRY BENCHMARK (SECTION 9.15)
CONTROLLER CUT-OFF VOLTAGE	16V		DRIVE STOPS
BATTERY CAPACITY		55Ah	SEE OPTIONS
BATTERY FUSIBLE LINKS	-	100A	IN-LINE FUSE ON EACH BATTERY
BATTERY CHARGER LOOM FUSIBLE LINK	-	15A	
BATTERY CHARGER	8A	8A	AUTOMATIC CYCLIC
MAX. KERB HEIGHT		50mm	
GROUND CLEARANCE		60mm	
REAR SUSPENSION TRAVEL		11mm	UNLADEN
FRONT SUSPENSION TRAVEL		23mm	UNLADEN
REAR WHEEL DRIVE	-	-	4 WHEEL SCOOTER
SCOOTER PUSH FORCE		100N	IN FREE-WHEEL
CRASH TESTED		NO	
TYRE PRESSURE		40psi	

### 15.3 MODEL: STERLING S700



ISO 7176-15	MIN.	MAX.	COMMENTS
OVERALL LENGTH	*1500mm	*1500mm	STANDARD CONFIGURATION
OVERALL WIDTH	657mm	657mm	STANDARD CONFIGURATION
TOTAL MASS (WITH BATTERIES)	145.5kg	145.5kg	STANDARD CONFIGURATION
MASS OF THE HEAVIEST PART	-	35kg	SEAT
STATIC STABILITY DOWNHILL	-	10°	160KG USER
STATIC STABILITY UPHILL	-	10°	160KG USER
STATIC STABILITY SIDEWAYS	-	10°	160KG USER
ENERGY CONSUMPTION (MAX. RANGE)	-	35 km	TO ISO 7176-14 (SEE SECTION 9.13)
DYNAMIC STABILITY UPHILL	-	10°-18%	160KG USER
OBSTACLE CLIMBING	-	100mm	STANDARD CONFIGURATION
RAMP TRANSITION	18°	18°	WITHOUT HIGH CENTRING
MAX. SPEED FORWARD		15 kph	STANDARD CONFIGURATION
MIN. BRAKE DISTANCE FROM MAX. SPEED	-	6m	WITH STANDARD PROGRAMMING
MAX. SPEED REVERSE	-	50%	% OF FORWARDS SPEED
EFFECTIVE SEAT DEPTH		490mm	STANDARD CONFIGURATION
EFFECTIVE SEAT WIDTH		490mm	STANDARD CONFIGURATION
SEAT SURFACE HEIGHT	450mm	500mm	TO SCOOTER FLOOR (3 POSITIONS)
BACK REST ANGLE	-70°	60°	FROM VERTICAL
BACK REST HEIGHT		525mm	STANDARD CONFIGURATION
FORE / AFT SEAT ADJUSTMENT		+30mm	FROM REAR MOST POSITION
SEAT WEIGHT WITH SLIDE		35kg	STANDARD CONFIGURATION
TOP OF ARM REST TO SEAT		230mm	ARM REST SET AT 90°
MIN. TURNING RADIUS		2950mm	STANDARD CONFIGURATION
MIN. TURN BETWEEN WALLS		2250mm	STANDARD CONFIGURATION
NOMINAL BATTERY VOLTAGE	24V	24V	TWO 12V BATTERIES
REVERSING WIDTH	2250mm		
<b>ADDITIONAL SPECIFICATIONS</b>	<b>MIN.</b>	<b>MAX.</b>	<b>COMMENTS</b>
MAXIMUM POTENTIAL RANGE		55 km	INDUSTRY BENCHMARK (SECTION 9.15)
CONTROLLER CUT-OFF VOLTAGE	16V		DRIVE STOPS
BATTERY CAPACITY		75Ah	SEE OPTIONS
BATTERY FUSIBLE LINKS	-	100A	IN-LINE FUSE ON EACH BATTERY
BATTERY CHARGER LOOM FUSIBLE LINK	-	15A	
BATTERY CHARGER		8A	AUTOMATIC CYCLIC
MAX. KERB HEIGHT		100 mm	
GROUND CLEARANCE	100 mm	130 mm	
REAR SUSPENSION TRAVEL		50 mm	UNLADEN
FRONT SUSPENSION TRAVEL		40 mm	UNLADEN
REAR WHEEL DRIVE	-	-	4 WHEEL SCOOTER
SCOOTER PUSH FORCE		100N	IN FREE-WHEEL
CRASH TESTED		NO	
TYRE PRESSURE		40psi	

\* Exceeds recommended dimensions.

## 16.0 Guarantee

### THIS GUARANTEE DOES NOT AFFECT YOUR LEGAL RIGHTS IN ANY WAY.

Sunrise Medical\* provides a guarantee, as set out in the warranty conditions, for products to its customers covering the following.

#### Warranty conditions:

1. Should a part or parts of the product require repair or replacement as a result of a manufacturing and/or material fault within 24 months, then the affected part or parts will be repaired or replaced free of charge. The warranty will only cover manufacturing defects
2. To enforce the warranty, please contact Sunrise Medical Customer Service with the exact details of the nature of the difficulty. Should you be using the product outside the area covered by the Sunrise Medical customer service agent, repairs or replacement will be carried out by another agency as designated by the manufacturer. The product must be repaired by a Sunrise Medical designated Customer Service agent, (dealer).
3. For parts, which have been repaired or exchanged within the scope of this warranty, we provide a warranty in accordance with these warranty conditions for the remaining warranty period for the product in accordance with point 1).
4. For original spare parts which have been fitted at the customer's expense, these will have a 12 months guarantee, (following the fitting), in accordance with these warranty conditions.
5. Claims from this warranty shall not arise, if a repair or replacement of a product or a part is required for the following reasons:
  - a. Normal wear and tear, which include but is not limited to the following parts where fitted; batteries, armrest pads, upholstery, tyres, brakes shoes, ferrules, etc.
  - b. Any overloading of the product, please check the EC label for maximum user weight.
  - c. The product or part has not been maintained or serviced in accordance with the manufacturer's recommendations as shown in the user instructions and/or the service instructions.
  - d. Accessories have been used which are not specified as original accessories.
  - e. The product or part having been damaged by neglect, accident or improper use.
  - f. Changes/modifications have been made to the product or parts, which deviate from the manufacturer's specifications.
  - g. Repairs have been carried out, before our Customer Service has been informed of the circumstances.
6. This guarantee is subject to the law of the country in which the product was purchased from Sunrise Medical"

\* Means the Sunrise Medical facility from which the product was purchased.

DEALER STAMP

## 17.0 Service Advice/History

This section is designed to assist you in keeping a record of any service and repairs to your scooter. The service Agent will complete this section and return the manual to you.

**NOTE:** Please contact your local Sunrise Medical approved servicing agent for any warranty, service or repair work required.

Model				
Serial Number				
Year	1	2	3	4
Service dates				
Controller				
On/Off switch				
Output plug				
Operation				
Dynamic braking				
Programmable configuration				
Batteries				
Physical Damage				
Connections				
Discharge tests				
Wheels/Tyres				
Wear				
Pressure				
Bearings				
Wheel nuts				
Motors				
Wiring				
Noises				
Connections				
Brakes				
Brushes				
Free-wheel Device				
Chassis				
Condition				
Steering				
Upholstery				
Seat				
Back				
Armrests				
Electric's				
Condition of loom				
Connections				
Lights & Indicators				
Test run				
Forward				
Reverse				
Emergency stop				
Left Turn				
Right Turn				
Up/Down slope				
Over obstacle				
Parking brake				



## 18.0 Service and Maintenance

After performing any maintenance or repairs on the scooter you must make sure that it is functioning correctly before it is used.

- Visually inspect the scooter to make sure its parts are correctly positioned and attached to the scooter and all fasteners are sufficiently tightened.
- Make sure that the seat is correctly fitted and adjusted.
- Switch on the scooter – Does the battery gauge flash? This signifies that there is a fault in the electronic system.
- Refer to section 8.0 for basic troubleshooting.
- Perform the parking brake check.
- Operate all of the electric options, including lights and indicators to make sure that they work correctly.
- Drive the scooter to make sure the scooter performs as it did before.

### **WARNING!**

- If you are in any doubt about the performance requirements of your scooter contact your Sunrise Medical authorised dealer.
- Only carry out the maintenance tasks listed below together with any general cleaning.
- Do not attempt any task you are not sure of.

## 18.1 RE-USE

The scooter is suitable for re-use by a second owner. Accessories can be quickly and easily removed/fitted and seating adjustments can be made to suit a second owner.



Please give this Owner's Manual to the second user.

**NOTE:** The warranty is not transferable.

Maintenance and Inspection Schedule	Daily	Weekly	Quarterly	Six month	Annually
Check battery level indicator and charge if necessary.	*				
Check the control levers on the tiller are not bent or damaged.	*				
Ensure all removable parts are securely fastened.	*				
Check lap strap for wear and make sure the buckle is operational.	*				
Check the Parking brake clicks on and off.		*			
Check tyres and inflate if required.		*			
Ensure any visible nuts and bolts are tight.		*			
Ensure all cables and connectors are sound and are tidy and out of the way.		*			
Clean the scooter and upholstery regularly.		*			
Battery terminal inspection – Remove any corrosion and apply Vaseline.			*		
Check upholstery, seating, headrests, arm pads for wear and check seat removal and refitting.				*	
Complete inspection, safety check and service should be made by a Sunrise Medical authorised dealer.					*

## 18.2 WHEEL REMOVAL

### WARNING!

- It is not usually practical to try to repair a puncture in situ at the site of the occurrence. Sunrise Medical suggest that you call for help to remove the scooter either directly to an approved service agent, or to a safe place for collection by the approved agent at a later time.
- If you are in any doubt about the servicing requirements of your scooter contact your Sunrise Medical authorised dealer.
- Do not attempt any task you are not sure of.
- Do not attempt a puncture repair if the scooter has stopped in an unsafe area. Move the scooter to a safe area away from traffic and other hazards.
- Do not attempt a puncture repair in busy pedestrian areas.
- Do not attempt a puncture repair if the scooter is causing an obstruction.
- If you are using a jack or other equipment, always follow the user instructions given in the related Owners' Manual or User Instructions.
- Be aware that the scooter may fall off the jack at any time.
- Keep hands and feet clear of the scooter when it is on the jack.
- Do not stand the jack on uneven surfaces.
- Always use a support block or stand in conjunction with the jack.
- The scooter must be in drive mode with the power switched OFF and the keys removed, before jacking any wheel off the ground.
- Do not raise more than one wheel of the ground at any one time.

**NOTE:** Reverse the following procedures to refit the wheels unless otherwise stated.

### 18.2.1 S-SERIES FRONT WHEEL REMOVAL

- Use a small phillips screw driver to undo the two screws securing the hub cover and remove it, (Fig.18.2)
- Use a 6.0mm Allen key/driver to loosen the nut, but do not remove it yet, (Fig.18.3).
- Elevate the front wheel by placing a jack under the relevant jack points, (Fig.18.1-18.1.1),
- When elevated, back up the jack with solid blocks to increase stability, (Fig18.4).
- Use a 6.00mm Allen key/driver or your fingers to remove the nut, (Fig.18.5).
- Do not lose the washers, (Fig.18.6).
- Withdraw the wheel off the tapered shaft, (Fig.18.7).
- The front wheel assembly is shown in Fig.18.8.

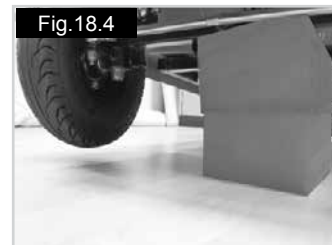
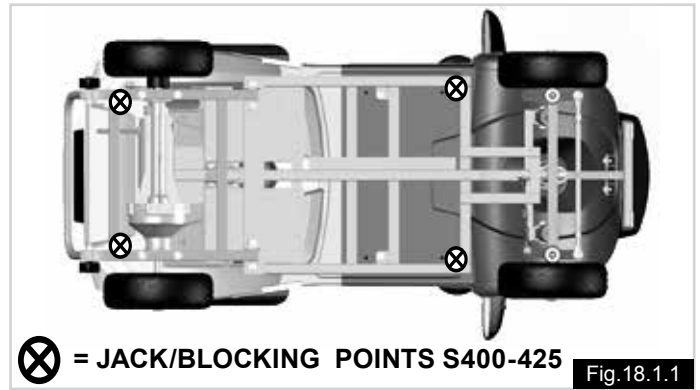
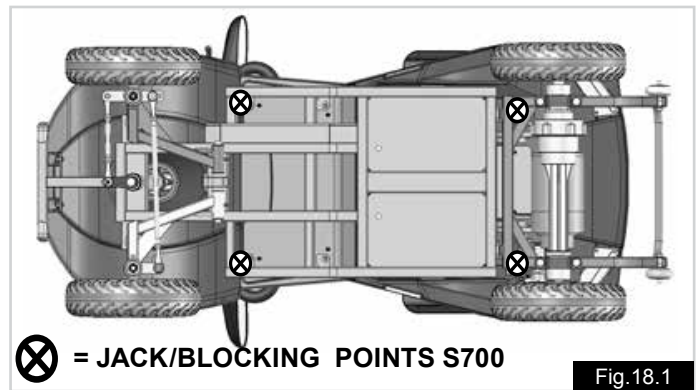

### 18.2.3 S-SERIES REAR WHEEL REMOVAL

**NOTE:** Points 1 and 2 and also 7 and 8 apply to the right hand wheel only and are not required for the left hand wheel.

1. Remove the seat, (Section 5.1).
2. Remove the battery cover, (Section 5.3).
3. Use a small Phillips screw driver to undo the two screws securing the hub cover and remove it, (Fig.18.9)
4. Use a 6.0mm Allen key/driver to loosen the nut, but do not remove it yet, (Fig.18.10).
5. Elevate the rear wheel by placing a jack under the relevant jack points, (Fig.18.1),
6. When elevated, back up the jack with solid blocks to increase stability, (Fig.18.11).
7. Locate the two screws securing the brake calliper and undo the screws using a 5.0 mm Allen key, (Fig.18.12).
8. Remove the brake calliper, (Fig.18.13).
9. Use a 6.0mm Allen key/driver or your fingers to remove the nut, (Fig.18.14).
10. Withdraw the wheel off the tapered shaft,, (Fig.18.15).
11. Withdraw the drive key from the tapered shaft, (Fig.18.16).
12. The rear, right hand wheel assembly is shown in Fig.18.17.

Fig.18.17



### 18.3 CHANGING THE INNER TUBE (ALL)

- Ensure any remaining air is expelled by pressing the valve with a small screwdriver and squeezing the tyre
- Use a 6.0mm Allen key/driver to undo the rim studs,
- Lift the outer rim off.
- Lift the tyre of the inner rim.
- Gently get hold of the inner tube just behind the valve.
- Carefully feed the tube out of the tyre.

#### To refit:

- Place the tube inside the tyre and rest it on the outer rim.
- Align the valve stem with the cut out on the rim.
- Face the valve stem outward.
- Place the inner rim over the tyre, tube and outer rim.
- Align the cut out to fit over the valve stem and match it up to the cut out in the outer rim.
- Make sure the stud mounts are in line on both rims.
- Tighten the studs evenly using the opposites sequence, going around once to close the rims and then again to tighten fully taking care not to pinch the tube.
- Slowly inflate to the appropriate pressure.

#### **WARNING!**

- Do not use high pressure air delivery systems such as those found on garage forecourts, to inflate the scooter tyres.
- Always use a new inner tube.

Fig.18.9

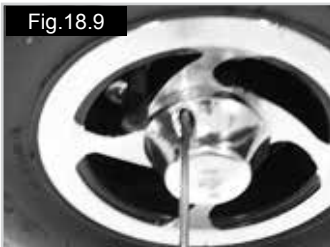

Fig.18.10



Fig.18.11



Fig.18.12

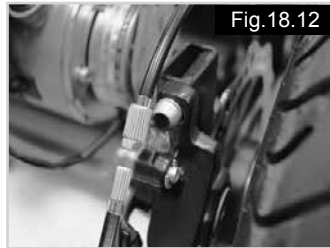

Fig.18.13



Fig.18.14



Fig.18.15



Fig.18.16



## 18.4 CHECKING THE TYRES

Check the tyres at least once a week for signs of wear and damage.

### Check for:

- Excessive wear on the tyre tread.
- Uneven wear over the surface of the tyre.
- Cuts or holes in the tyre tread.
- Cuts or holes in the tyre walls.
- Sharp objects stuck in the tyre.
- Tyre pressures.
- Tyre studs/nuts are tight.
- Damage to wheel rims.
- Foreign materials/contaminants. (Fig.18.40-18.41)

### WARNING!

- Put the scooter in drive, switch the scooter off and remove the key before carrying out the checks.
- Never use the scooter if the tyres are found to be defective after carrying out the above checks.
- Wear protective gloves if you have to physically touch the tyres or undercarriage and afterwards wash you hands thoroughly.

## 18.5 WHEEL SIZES

S400	Wheel Size
Front	10 Inches / 25 cms
Rear	10 Inches / 25 cms
S425	Wheel Size
Front	12 Inches / 30 cms
Rear	12 Inches / 30 cms
S700	Wheel Size
Front	13 Inches / 33 cms
Rear	13 Inches / 33 cms

## 19.0 Nameplate

The nameplate is located on the seat post of the scooter, as well as on a label in the owner's manual. The nameplate indicates the exact model designation and other technical specifications. Please provide the following pieces of information whenever you have to order replacement parts or to file a claim:

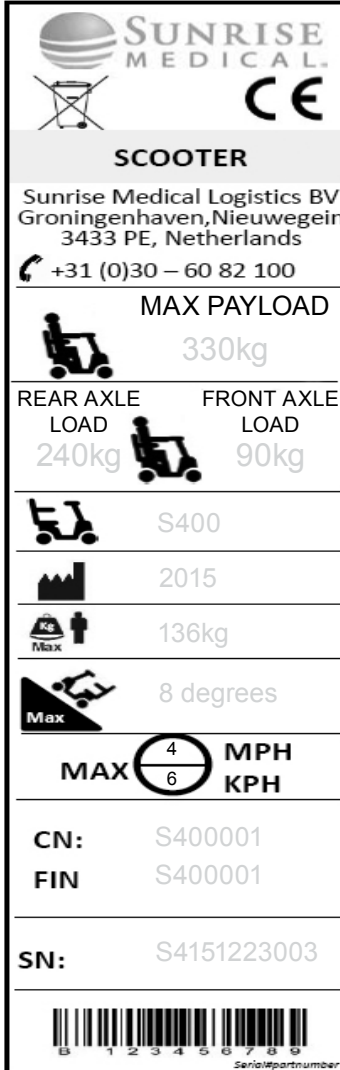

**SUNRISE MEDICAL** 

**SCOOTER**

Sunrise Medical Logistics BV  
Groningenhaven, Nieuwegein  
3433 PE, Netherlands  
+31 (0)30 – 60 82 100

**MAX PAYLOAD**  
330kg

REAR AXLE LOAD	240kg	FRONT AXLE LOAD	90kg
----------------	-------	-----------------	------

 S400

 2015

 Max 136kg

 Max 8 degrees

**MAX**  **MPH**  
**KPH**

CN: S400001  
FIN: S400001

SN: S4151223003

  
Serial#partnumber

**NOTE:** The above serial number diagram is an example only. Actual weights and numbers will vary according to product type.

Due to our policy of continuous improvement in the design of our wheelchairs, product specifications may vary slightly from the examples illustrated. All weight/dimensions and performance data are approximate and provided solely for guidance.

Sunrise Medical complies with the EU Medical Devices Directive 93/42/EEC



All wheelchairs must be used in accordance with the manufacturer's guidelines.

Sunrise Medical Logistics B.V.  
Groningenhaven 18-20  
3433 PE NIEUWEGEIN  
The Netherlands  
T: +32 (0)800 – 24 800  
F: +32 (0)3 – 844 68 03  
E: info@sunrisemedical.be  
www.SunriseMedical.be











- UK = [www.SunriseMedical.co.uk](http://www.SunriseMedical.co.uk)
- DE = [www.SunriseMedical.de](http://www.SunriseMedical.de)
- FR = [www.sunrisemedical.fr](http://www.sunrisemedical.fr)
- IT = [www.SunriseMedical.it](http://www.SunriseMedical.it)
- NL = [www.SunriseMedical.nl](http://www.SunriseMedical.nl)
- ES = [www.SunriseMedical.es](http://www.SunriseMedical.es)
- PT = [www.SunriseMedical.pt](http://www.SunriseMedical.pt)
- SE = [www.SunriseMedical.se](http://www.SunriseMedical.se)
- NO = [www.SunriseMedical.no](http://www.SunriseMedical.no)
- DK = [www.SunriseMedical.dk](http://www.SunriseMedical.dk)
- CH = [www.SunriseMedical.ch](http://www.SunriseMedical.ch)
- CZ = [www.medicco.cz](http://www.medicco.cz)
- PL = [www.Sunrise-Medical.pl](http://www.Sunrise-Medical.pl)
- EU = [www.SunriseMedical.eu](http://www.SunriseMedical.eu)
- AU = [www.sunrisemedical.com.au](http://www.sunrisemedical.com.au)
- US = [www.SunriseMedical.com](http://www.SunriseMedical.com)

