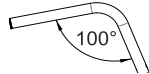
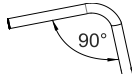
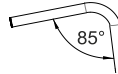

Date	UK (English)	
User	Company stamp	Folding frame wheelchair
End user weight (kg)		£ 4064,00
Language user manual	Responsible	Retail price - VAT not included

Wheelchair measures						
Seat width (LS)	<input type="checkbox"/> 33	<input type="checkbox"/> 36	<input type="checkbox"/> 39	<input type="checkbox"/> 42	<input type="checkbox"/> 45	<input type="checkbox"/> 48
<small>The seat width is measured from the outer sides of the frame, while the distance between the two side guards is 1 cm wider.</small>						
Seat depth (PS)	<input type="checkbox"/> 35	<input type="checkbox"/> 37,5	<input type="checkbox"/> 40	<input type="checkbox"/> 42,5	<input type="checkbox"/> 45	<input type="checkbox"/> 47,5
<small>The real seat depth, from the front part of the seat cloth to the backrest tube will be 1,5 cm more than the declared one.</small>						
Footplate distance (DP) (cm) ±0.5cm - adjustment steps 1.5cm					
<small>(Real distance between seat and footplate) - IMPORTANT NOTICE! From the footplate to the floor minimum 4cm !! (Minimum Front height = DP + 4cm.)</small>						
Setting	<input checked="" type="checkbox"/> Standard	<input type="checkbox"/> Prudential	<input type="checkbox"/> Active			
Backrest Height (TS)	Std. Value 33,5 (min 24.5-max 47) adjustment steps 1.5cm					
camber	<input checked="" type="checkbox"/> 0°	<input type="checkbox"/> 2°				
Front height STD 49					
Rear height STD 42					

Front frame	
<input checked="" type="checkbox"/> Aluminium standard frame <div style="display: flex; justify-content: space-around;"> <div style="text-align: center;">  <input checked="" type="checkbox"/> </div> <div style="text-align: center;">  <input type="checkbox"/> (max 5" caster) </div> <div style="text-align: center;">  <input type="checkbox"/> (max 4" caster) </div> </div>	<div style="border: 1px solid black; padding: 5px;"> Colour aluminium frame <input checked="" type="checkbox"/> Bright silver <input type="checkbox"/> Polished black <input type="checkbox"/> Opaque black <input type="checkbox"/> Bright blue <input type="checkbox"/> Bright anthracite <input type="checkbox"/> Bright orange <input type="checkbox"/> Bright fuchsia <input type="checkbox"/> Bright red <input type="checkbox"/> Bright lime <input type="checkbox"/> Bright blue china <input type="checkbox"/> Pearl white </div>

Backrest	<input checked="" type="checkbox"/> Adjustable velcro straps and padded transpiring upholstery
-----------------	--

Handle tube	<input checked="" type="checkbox"/> Tubes with short handle <input type="checkbox"/> SPORT tubes Without push handles (Lightest configuration) <input type="checkbox"/> Folding handles	 02958 252,00
--------------------	---	--

Casters	<input checked="" type="checkbox"/> 4" Soft <input type="checkbox"/> 3" Sport (Lightest configuration) <input type="checkbox"/> 5" Soft <input type="checkbox"/> 6" Soft (Available only with 100° angle) <input type="checkbox"/> 6" Pneumatic (Available only with 100° angle)	
	<input type="checkbox"/> 3" Active Soft (wide) (Aluminium alloy rim) 06824 126,00 <input type="checkbox"/> 4" Active Sport (narrow) (Aluminium alloy rim) 01398 126,00 <input type="checkbox"/> 4" Active Soft (wide) (Aluminium alloy rim) 03943 126,00 <input type="checkbox"/> 5" Active Soft (wide) (Aluminium alloy rim) 07518 126,00 <input type="checkbox"/> 5" Pneumatic 10844 63,00	

Support front fork	<input checked="" type="checkbox"/> Standard support front fork <input type="checkbox"/> Front fork support V Design 2.0 <small>Exclude the installation of : Quick release front forks</small>
---------------------------	---

Date	Order	User	Address
------------	-------------	------------	---------------

Special Options		
<input type="radio"/> Rear wheels plate extension	01950	177,00
<input type="radio"/> lockingband/strip to close/fold the wheelchair	06833	23,00
<input type="radio"/> Drawstring to unlock the back with a singleaction	06834	126,00

Colour set: Rear wheels and forks - To be matched only with: Rear wheels Ultra-light Progeo - Standard! (22 - 24)		
☆ Black	22" 24" 25" 26"	
<input type="radio"/> Bright silver	22" 24"	00833 126,00
<input type="radio"/> Bright anthracite	24"	00833 126,00
<input type="radio"/> Bright orange	22" 24"	00833 126,00
<input type="radio"/> Bright fuchsia	22" 24"	00833 126,00
<input type="radio"/> Bright blue	22" 24"	00833 126,00
<input type="radio"/> Bright red	22" 24"	00833 126,00
<input type="radio"/> Bright lime	22" 24"	00833 126,00
<input type="radio"/> Pearl white	22" 24"	00833 126,00

Rear wheels		
☆ 24" Ultra-light Progeo - Standard!		
<input type="checkbox"/> 22" Ultra-light Progeo - Standard!		
<input type="checkbox"/> 25" Ultra-light Progeo - Standard!	(colour: black)	
<input type="checkbox"/> 26" Progeo - Standard!	(colour: black)	
<input type="radio"/> 24" ULTRA-LIGHT PROGEO KEY SPORT	(Lightest configuration)	04383 876,00
<input type="radio"/> 24" Ultra-light "Spinergy LX"		01685 876,00
<input type="radio"/> 24" Ultra-light "Spinergy LXL"	<input type="checkbox"/> Black hub and white spokes <input type="checkbox"/> Hub and spokes black	07846 876,00
<input type="radio"/> 24" Ultra-light "Spinergy Flex rim"	Integrated aluminium/rubber handrim	02270 1.374,00
<input type="radio"/> 25" Ultra-light "Spinergy LX"		02101 876,00
<input type="radio"/> 25" Ultra-light "Spinergy LXL"	<input type="checkbox"/> Black hub and white spokes	07847 876,00
<input type="radio"/> 26" Ultra-light "Spinergy LX"		02102 876,00
<input type="radio"/> 24" Off-road (aluminium handrim black)		01392 224,00

Rear wheel tyre		
☆ High pressure tyre	(22"-24"-25"-26")	(Lightest configuration)
<input type="checkbox"/> High pressure profile tyre	(24")	
<input type="radio"/> Marathon Plus	(24"-25")	with anti-puncture protection
<input type="radio"/> Anti-puncture - Colour Black	(24")	01669 63,00
<input type="radio"/> Anti-puncture - Colour Grey	(22")	11083 126,00
<input type="radio"/> Anti-puncture - Colour Grey	(22")	04181 98,00

Handrim		
	Wheel distance	☆ 3 cm <input type="checkbox"/> 4 cm
☆ Aluminium	(22"-24"-25"-26")	(Lightest configuration)
<input type="radio"/> Aluminium black SOFT-TOUCH	(24"-25")	(24" handrim, on 25" wheel is installed with spacers)
<input type="radio"/> Chromed Steel	(24"-25")	(24" handrim, on 25" wheel is installed with spacers)
<input type="radio"/> Titanium	(24"-25")	(24" handrim, on 25" wheel is installed with spacers)
<input type="radio"/> Ultra Grepp	(24"-25")	(24" handrim, on 25" wheel is installed with spacers)
<input type="radio"/> Max Grepp	(24"-25")	(24" handrim, on 25" wheel is installed with spacers)
<input type="radio"/> Ergo Para	(24")	(24" handrim, on 25" wheel is installed with spacers)
<input type="radio"/> TOP FRICTION	(24"-25")	(24" handrim, on 25" wheel is installed with spacers)
Oval countour with a rubber insert		
<input type="radio"/> NOVA H	(24"-25")	(24" handrim, on 25" wheel is installed with spacers)
Ergonomic black profile		
<input type="radio"/> NOVA D	(24"-25")	(24" handrim, on 25" wheel is installed with spacers)
Ergonomic profile with rubber coating (ideal for quadriplegics)		
<input type="radio"/> SURGE LT	(25")	Oval countour with a rubber insert
<input type="radio"/> Quad	(24")	
<input type="radio"/> Silicon cover for standard aluminium handrim		Available for measures (22"- 24" - 26")

Wheel locks		
☆ Bent lever push to lock		06428 126,00
<input type="checkbox"/> Straight lever push to lock		
<input type="checkbox"/> Straight lever pull to lock		
<input type="radio"/> Sport brake	(Lightest configuration)	

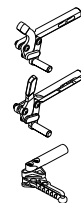

Permobil Limited Unit 7, Polaris Centre, 41 Brownfields, Welwyn Garden City, Herts, AL7 1AN United Kingdom - Phone: +44 1484 722888

customer_support_uk@permobil.com - https://www.permobil.com/en-gb

Date Order User Address

Automatic Closure footplate

☆ Footplate COMPACT, automatic Closure (Lightest configuration)  11529 **no list**

Minimum footplate distance 35cm. **RAKE AND DEPTH ADJUSTABLE**

Internal External

Footplate - See reference tables N°3

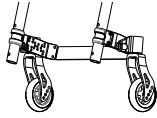
Warning!! All flip-up footrests, need a stretch calf band and standard fork-support 

Weight increase approx. 500gr.

Plastic footrest. rake adjustable  11525 **no list**
 Minimum footplate distance 35cm. ☆ 2/3 Internal 2/3 External

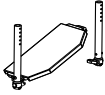
One piece footplate - Flip-up!. rake and depth adjustable  11527 **no list**
 Minimum footplate distance 35cm. Internal ☆ 2/3 Internal External

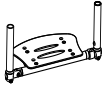
One piece aluminium footplate - Flip-up!. rake and depth adjustable  11528 **no list**
 Minimum footplate distance 35cm. Internal ☆ 2/3 Internal 2/3 External

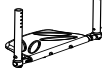
One piece Carbon fibre footplate, rake adjustable, swing away, flip-up.  03291 **275,00**
 Minimum footplate distance 35cm. ☆ Internal External

Mudguard

Mudguard - FIXED

☆ Carbon fibre mudguard 

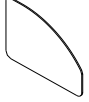
Carbon fibre Straight sideguard 

Extra charge for : REMOVABLE VERSION  08921 **126,00**

Armrests

Tubular armrests (Swing away, removable and height adjustable armrest)  00694 **252,00**

Removable armrest with ABS mudguard

Desk armrests PROGEO (Removable and height adjustable)  09956 **224,00**

Removable armrest with carbon-fiber straight sideguard  09079 **224,00**

Accessories



Pad for front frame protectors 07058 **52,00**

Backrest-seat connection cloth 10241 **17,00**

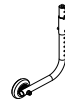

Removable storage bag (with quick coupling) 09811 **126,00**

Date	Order	User	Address
------------	-------------	------------	---------------

Optional 1

<input type="radio"/> Transit wheels			00836	148,00
<input type="radio"/> Anti-tipper with rapid hookup	(inside rotation to reduce the encumbrance)			
	<input type="radio"/> Right		00023	126,00
	<input type="radio"/> Left		00024	126,00
<input type="radio"/> Tipping aid	<input type="radio"/> Right		00025	74,00
	<input type="radio"/> Left		01046	74,00
<input type="radio"/> Crutches support	<input type="radio"/> Right		00838	74,00
	<input type="radio"/> Left		00837	74,00

Optional 2

<input type="radio"/> Tetraclip	(Quick release axle for quadriplegic)		03947	177,00
<input type="radio"/> Safety pelvic belt			03972	63,00
<input type="radio"/> Harness			04103	126,00
<input type="radio"/> Quick release front forks	Available with: Standard support front fork		00030	148,00
<input type="radio"/> Push handles for companion	(Removable and height adjustable)		01048	189,00
<input type="radio"/> Lumbar support	(to insert in the backrest upholstery)		00013	40,00
<input type="radio"/> Swing away lateral support	Not available with Posture backrest PHYSIO			
	<input type="radio"/> Right		02097	252,00
	<input type="radio"/> Left		02098	252,00
<input type="radio"/> Spoke guards Black	(22"-24")		01043	148,00
<input type="radio"/> Spoke guards Transparent	(22"-24")		00835	148,00
<input type="radio"/> Spoke guards Progeo design	(22"-24")		00019	177,00
<input type="radio"/> Spoke guards Dragon	(22"-24")		02106	177,00

Additional Kit







<input type="radio"/> 24" Off-road rear wheels	Off-Road tyre - aluminium handrim (black colour)		03378	498,00
<input type="radio"/> 24" FAT rear wheels	FAT tyre 3" - aluminium handrim (black colour)		09357	876,00

Date Order User Address

PHYSIO - Posture backrest (Std. Backrest upholstery not provided)



Removable with quick release
Suitable for tubes with diameter 18+26mm
Depth adjustment (4cm)
Angle adjustment ($\pm 18^\circ$)

- AIR** Carbon shell
not available for seat width 48

BACKREST HEIGHT	28	34	40			
Shell's shape  7,5 cm	Lateral retaining wing A=high - R=regular					
	A	R	A	R	A	R
						
	<input type="checkbox"/>	<input type="checkbox"/>	<input type="checkbox"/>	<input type="checkbox"/>	<input type="checkbox"/>	<input type="checkbox"/>

1.047,00

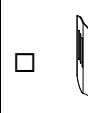
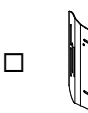
- POSTURE** Aluminum shell

BACKREST HEIGHT	34	40	52
Shell's shape  7,5 cm	Lateral retaining wing B=regular		
	R	R	R
			
	<input type="checkbox"/>	<input type="checkbox"/>	<input type="checkbox"/>

1.013,00

Configuration DEEP with side support PAD (height adjustable)

- Alluminum lateral with padded, breathable upholstery.



Small (h 13cm)



Right
10272

29,00

Left
10272

29,00

Large (h 20cm)



Right
10273

40,00

Left
10273

40,00

SWING AWAY - Lateral support

Fixing and adjustment hardware complete with protection sleeve
Alluminum lateral with padded, breathable upholstery.

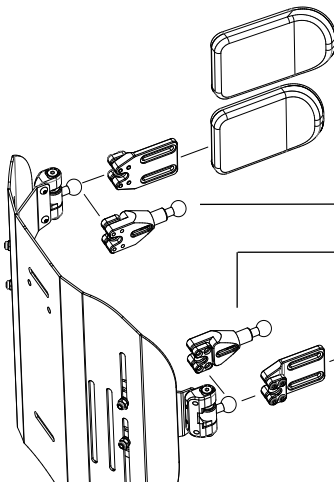

- Large (18x12)

05647 183,00

- Small (14x9)

05643 183,00

- Lateral support extension

Quantity (number pcs).....
10271 69,00

- Lateral support extension

Quantity (number pcs).....

- Small (14x9)

05642 183,00

- Large (18x12)

05646 183,00

- Headrest adjustable - Double ball mounting system

Available only with backrest Physio
Not available for backrest Physio AIR carbon shell



- Large (34x14)

05648 252,00



- Small (28x14)

Date	Order	User	Address
------------	-------------	------------	---------------

Note

Wheelchair : Progeo EGO - Rev. 2023.1	Prices - VAT excluded <small>to be added to the price list</small>	<table border="1" style="width: 100%; border-collapse: collapse;"> <tr> <td colspan="2" style="text-align: center; padding: 2px;">Send this page only if any optional have been chosen</td> </tr> <tr> <td style="padding: 2px;"><input type="checkbox"/> standard</td> <td style="padding: 2px;"><small>(supplied if no requests are indicated)</small></td> </tr> <tr> <td style="padding: 2px;"><input type="checkbox"/> on request</td> <td style="padding: 2px;"><small>(without extra charge)</small></td> </tr> <tr> <td style="padding: 2px;"><input type="checkbox"/> optional</td> <td style="padding: 2px;"><small>(cost to be added at the basic price)</small></td> </tr> </table>	Send this page only if any optional have been chosen		<input type="checkbox"/> standard	<small>(supplied if no requests are indicated)</small>	<input type="checkbox"/> on request	<small>(without extra charge)</small>	<input type="checkbox"/> optional	<small>(cost to be added at the basic price)</small>
Send this page only if any optional have been chosen										
<input type="checkbox"/> standard	<small>(supplied if no requests are indicated)</small>									
<input type="checkbox"/> on request	<small>(without extra charge)</small>									
<input type="checkbox"/> optional	<small>(cost to be added at the basic price)</small>									

REFERENCE TABLES

1		Front height			
		With closed frame (95°) max 5" caster			
		With closed frame (90°) max 5" caster			
		With closed frame (85°) max 4" caster			
		Casters			
FORK		3"	4"	5"	6"
SMALL 		max 46	max 47	max 48	
MEDIUM 		max 50	max 51	max 52	max 54
The size of the fork will be defined only by Progeo in accordance with wheelchair final configuration.					

2		Rear height			
		Rear wheels			
		22"	24"	25"	26"
min		min	min	min	min
35		38	39	40	
max		max	max	max	max
43		45	46	48	

3	Footplate option	Footplate distance
	Footplate COMPACT, automatic Closure	min 36
	Plastic footrest	min 36
	One piece footplate - Flip-up!	min 36
	One piece aluminium footplate - Flip-up!	min 36
	One piece Carbon fibre footplate	min 36
IMPORTANT NOTICE! From the footplate to the floor minimum 4cm !! (Minimum Front height = DP + 4cm.)		
NOTE! Lower footplate distances are possible only after our valuation		
Calculated with the best configuration and with the footplates positioned on inside.		

4	Rear wheels	
	Model	Features
	22" Ultra-light Progeo - Standard!	(not available in anthracite color)
	24" Ultra-light Progeo - Standard!	(available for all colors)
	24" ULTRA-LIGHT PROGEO KEY SPORT	(silver hub, black rim and 16 spokes)
	24" Ultra-light "Spinergy LX"	(silver hub, black rim and spokes)
	24" Ultra-light "Spinergy LXL"	(black hub and rim, 18 white spokes) - (black hub, rim and 18 spokes)
	24" Ultra-light "Spinergy Flex rim"	(silver hub, black rim and spokes) - (integrated aluminium/rubber handrim - encumbrance reduction up to 3cm. - all tyre)
	24" Off-road	(colour: black) - (aluminium handrim - tyre Off-road)
	25" Ultra-light "Spinergy LX"	(silver hub, black rim and spokes)
	25" Ultra-light "Spinergy LXL"	(black hub and rim, 18 white spokes)
	26" Progeo - Standard!	(colour: black)
	26" Ultra-light "Spinergy LX"	(silver hub, black rim and 18 spokes)