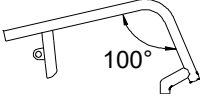
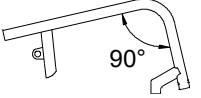
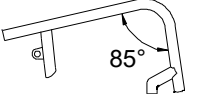
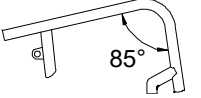

Permobil Limited Unit 7, Polaris Centre, 41 Brownfields, Welwyn Garden City, Herts, AL7 1AN United Kingdom - Phone: +44 1484 722888

customer_support_uk@permobil.com - https://www.permobil.com/en-gb

Date	UK (English)	
User	Company stamp	Folding frame wheelchair
End user weight (kg)		£ 4579,00
Language user manual	Responsible	Retail price - VAT not included

Wheelchair measures	
Keep attention to all measures.	
EGO CUSTOM is a welded frame wheelchair, thus seat height and setting can not be modified after its manufacturing.	
Seat width (LS) <input type="checkbox"/> 33 <input type="checkbox"/> 36 <input type="checkbox"/> 39 <input type="checkbox"/> 42 <input type="checkbox"/> 45 <input type="checkbox"/> 48	The seat width is measured from the outer sides of the frame, while the distance between the two side guards is 1 cm wider.
Seat depth (PS) <input type="checkbox"/> 35 <input type="checkbox"/> 37,5 <input type="checkbox"/> 40 <input type="checkbox"/> 42,5 <input type="checkbox"/> 45 <input type="checkbox"/> 47,5	The real seat depth, from the front part of the seat cloth to the backrest tube will be 1,5 cm more than the declared one.
Footplate distance (DP)	(cm) ±0.5cm - adjustment steps 1.5cm (Real distance between seat and footplate) - IMPORTANT NOTICE! From the footplate to the floor minimum 4cm !! (Minimum Front height = DP + 4cm.)
Setting	<input checked="" type="checkbox"/> Standard <input type="checkbox"/> Prudential <input type="checkbox"/> Active
Backrest Height (TS)	Std.Value 33,5(min 24.5-max 47) adjustment steps 1.5cm
camber	<input checked="" type="checkbox"/> 0° <input type="checkbox"/> 2°
Front height (min 44-max 52)
Rear height (min 38-max 45)
	calculated with rear wheels 24"

Front frame	
Aluminium frame - welded made-to-measure	
Footplate COMPACT, automatic Closure adjustable distance +/- 1,5cm	
<input type="checkbox"/> 	<input type="checkbox"/> 
(max 5" caster)	(max 5" caster)
<input type="checkbox"/> 	<input type="checkbox"/> 
(max 5" caster)	(max 4" caster)
Frame colour (without extra charge)	
<input type="checkbox"/> Bright silver	<input type="checkbox"/> Pearl white
<input type="checkbox"/> Opaque black	<input type="checkbox"/> Polished black
Frame colour on request	
<input type="radio"/> Metallic matt blue	<input type="radio"/> Metallic matt grey
<input type="radio"/> Metallic matt anthracite	09194 372,00

Backrest
☆ Adjustable velcro straps and padded transpiring upholstery

Handle tube	
☆ Tubes with short handle	
<input type="checkbox"/> SPORT tubes Without push handles	(Lightest configuration)
<input type="radio"/> Folding handles	 02958 252,00

Casters	
☆ 4" Soft	
<input type="checkbox"/> 3" Sport	(Lightest configuration)
<input type="checkbox"/> 5" Soft	
<input type="radio"/> 3" Active Soft (wide)	(Aluminium alloy rim) 06824 126,00
<input type="radio"/> 4" Active Sport (narrow)	(Aluminium alloy rim) 01398 126,00
<input type="radio"/> 4" Active Soft (wide)	(Aluminium alloy rim) 03943 126,00
<input type="radio"/> 5" Active Soft (wide)	(Aluminium alloy rim) 07518 126,00
<input type="radio"/> 5" Pneumatic	10844 63,00

Permobilit Limited Unit 7, Polaris Centre, 41 Brownfields, Welwyn Garden City, Herts, AL7 1AN United Kingdom - Phone: +44 1484 722888

customer_support_uk@permobil.com - https://www.permobil.com/en-gb

Date	Order	User	Address
------------	-------------	------------	---------------

Special Options		
<input type="radio"/> lockingband/strip to close/fold the wheelchair	06833	23,00
<input type="radio"/> Drawstring to unlock the back with a singleaction	06834	126,00

Colour set: Rear wheels and forks - To be matched only with: Rear wheels Ultra-light Progeo - Standard! (22 - 24)		
<input checked="" type="radio"/> Black	22" 24" 25" 26"	
<input type="radio"/> Bright silver	22" 24"	00833 126,00
<input type="radio"/> Bright fuchsia	22" 24"	00833 126,00
<input type="radio"/> Bright blue	22" 24"	00833 126,00
<input type="radio"/> Bright red	22" 24"	00833 126,00
<input type="radio"/> Bright lime	22" 24"	00833 126,00
<input type="radio"/> Pearl white	22" 24"	00833 126,00



Rear wheels		
<input checked="" type="radio"/> 24" Ultra-light Progeo - Standard!		
<input type="checkbox"/> 22" Ultra-light Progeo - Standard!		
<input type="checkbox"/> 25" Ultra-light Progeo - Standard!	(colour: black)	
<input type="checkbox"/> 26" Progeo - Standard!	(colour: black)	
<input type="radio"/> 24" ULTRA-LIGHT PROGEO KEY SPORT	(Lightest configuration)	04383 876,00
<input type="radio"/> 24" Ultra-light "Spinergy LX"		01685 876,00
<input type="radio"/> 24" Ultra-light "Spinergy LXL"	<input type="checkbox"/> Black hub and white spokes <input type="checkbox"/> Hub and spokes black	07846 876,00
<input type="radio"/> 24" Ultra-light "Spinergy Flex rim"	Integrated aluminium/rubber handrim	02270 1.374,00
<input type="radio"/> 25" Ultra-light "Spinergy LX"		02101 876,00
<input type="radio"/> 25" Ultra-light "Spinergy LXL"	<input type="checkbox"/> Black hub and white spokes	07847 876,00
<input type="radio"/> 26" Ultra-light "Spinergy LX"		02102 876,00
<input type="radio"/> 24" Off-road (aluminium handrim black)		01392 224,00

Rear wheel tyre		
<input checked="" type="radio"/> High pressure tyre	(22"-24"-25"-26")	(Lightest configuration)
<input type="checkbox"/> High pressure profile tyre	(24")	
<input type="radio"/> Marathon Plus	(24"-25")	with anti-puncture protection
<input type="radio"/> Anti-puncture - Colour Black	(24")	11083 126,00
<input type="radio"/> Anti-puncture - Colour Grey	(22")	04181 98,00

Handrim	Wheel distance			
	★ 3 cm	□ 4 cm		
<input checked="" type="radio"/> Aluminium	(22"-24"-25"-26")	(Lightest configuration)		
<input type="radio"/> Aluminium black SOFT-TOUCH	(24"-25")	(24" handrim, on 25" wheel is installed with spacers)	09170	126,00
<input type="radio"/> Chromed Steel	(24"-25")	(24" handrim, on 25" wheel is installed with spacers)	01684	148,00
<input type="radio"/> Titanium	(24"-25")	(24" handrim, on 25" wheel is installed with spacers)	00016	275,00
<input type="radio"/> Ultra Grepp	(24"-25")	(24" handrim, on 25" wheel is installed with spacers)	00017	315,00
<input type="radio"/> Max Grepp	(24"-25")	(24" handrim, on 25" wheel is installed with spacers)	00834	349,00
<input type="radio"/> Ergo Para	(24")		00632	349,00
<input type="radio"/> TOP FRICTION	(24"-25")	(24" handrim, on 25" wheel is installed with spacers)	11023	399,00
Oval countour with a rubber insert				
<input type="radio"/> NOVA H	(24"-25")	(24" handrim, on 25" wheel is installed with spacers)	11025	263,00
Ergonomic black profile				
<input type="radio"/> NOVA D	(24"-25")	(24" handrim, on 25" wheel is installed with spacers)	11026	286,00
Ergonomic profile with rubber coating (ideal for quadriplegics)				
<input type="radio"/> SURGE LT	(25")	Oval countour with a rubber insert	06427	360,00
<input type="radio"/> Quad	(24")		00693	200,00
<input type="radio"/> Silicon cover for standard aluminium handrim		Available for measures (22" - 24" - 26")	04050	160,00

Date Order User Address

Wheel locks



- Bent lever push to lock 
- Straight lever push to lock 
- Straight lever pull to lock
- Sport brake  (Lightest configuration) 06428 **126,00**

Automatic Closure footplate



- Footplate COMPACT, automatic Closure  (Lightest configuration) 11529 **no list**
- Minimum footplate distance 35cm. RAKE AND DEPTH ADJUSTABLE
- Internal External

Mudguard

Mudguard - FIXED

- Carbon fibre mudguard 
- Carbon fibre Straight sideguard 
- Extra charge for : REMOVABLE VERSION  08921 **126,00**

Armrests

- Tubular armrests  (Swing away, removable and height adjustable armrest) 00694 **252,00**
Exclude the installation OPTIONAL 1
- Removable armrest with ABS mudguard
- Desk armrests PROGEO  (Removable and height adjustable) 09956 **224,00**
- Removable armrest with carbon-fiber straight sideguard  09079 **224,00**

Accessories





- Pad for front frame protectors 07058 **52,00**
- Backrest-seat connection cloth 10241 **17,00**
- Removable storage bag (with quick coupling) 09811 **126,00**

Date Order User Address



Optional 1

Important notice! With the EGO CUSTOM you may choose only one of these accessories with fee

Attention none of these accessories are available if have been chosen the Tubular armrests

<input type="radio"/> Transit wheels			00836	148,00
<input type="radio"/> Anti-tipper with rapid hookup	(inside rotation to reduce the encumbrance) <input type="radio"/> Right <input type="radio"/> Left		00023 00024	126,00 126,00
<input type="radio"/> Tipping aid	<input type="radio"/> Right <input type="radio"/> Left		00025 01046	74,00 74,00
<input type="radio"/> Crutches support	<input type="radio"/> Right <input type="radio"/> Left		00838 00837	74,00 74,00

Optional 2

<input type="radio"/> Tetracrip	(Quick release axle for quadriplegic)		03947	177,00
<input type="radio"/> Safety pelvic belt			03972	63,00
<input type="radio"/> Harness			04103	126,00
<input type="radio"/> Push handles for companion	(Removable and height adjustable)		01048	189,00
<input type="radio"/> Lumbar support	(to insert in the backrest upholstery)		00013	40,00
<input type="radio"/> Swing away lateral support	<input type="radio"/> Right <input type="radio"/> Left		02097 02098	252,00 252,00
Not available with Posture backrest PHYSIO				
<input type="radio"/> Spoke guards Black	(22"-24")		01043	148,00
<input type="radio"/> Spoke guards Transparent	(22"-24")		00835	148,00
<input type="radio"/> Spoke guards Progeo design	(22"-24")		00019	177,00
<input type="radio"/> Spoke guards Dragon	(22"-24")		02106	177,00

Additional Kit

<input type="radio"/> 24" Off-road rear wheels	Off-Road tyre - aluminium handrim (black colour)	03378	498,00
<input type="radio"/> 24" FAT rear wheels	FAT tyre 3" - aluminium handrim (black colour)	09357	876,00

Date Order User Address

PHYSIO - Posture backrest (Std. Backrest upholstery not provided)

Removable with quick release
Suitable for tubes with diameter 18+26mm
Depth adjustment (4cm)
Angle adjustment (±18°)

- AIR** Carbon shell
not available for seat width 48

BACKREST HEIGHT	28	34	40	
Shell's shape 	Lateral retaining wing A=high - R=regular			
	A	R	A	R
	<input type="checkbox"/>	<input type="checkbox"/>	<input type="checkbox"/>	<input type="checkbox"/>

1.047,00

- POSTURE** Aluminum shell

BACKREST HEIGHT	34	40	52	
Shell's shape 	Lateral retaining wing B=regular			
	R	R	R	
	<input type="checkbox"/>	<input type="checkbox"/>	<input type="checkbox"/>	

1.013,00

Configuration DEEP with side support PAD (height adjustable)

- Aluminum lateral with padded, breathable upholstery.



Small (h 13cm)



Right
10272

29,00

Left
10272

29,00

Large (h 20cm)



Right
10273

40,00

Left
10273

40,00

SWING AWAY - Lateral support

Fixing and adjustment hardware complete with protection sleeve
Aluminum lateral with padded, breathable upholstery.

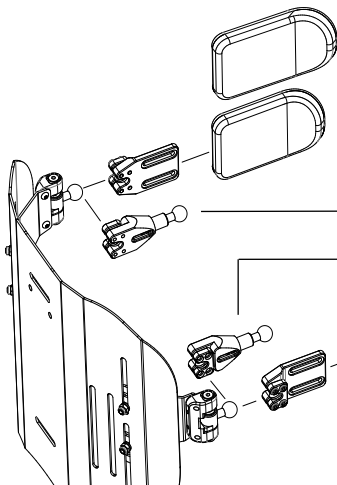

- Large (18x12)

05647 183,00

- Small (14x9)

05643 183,00

- Lateral support extension

Quantity (number pcs).....

- Lateral support extension

Quantity (number pcs)..... 10271 69,00

- Small (14x9)

05642 183,00

- Large (18x12)

05646 183,00

- Headrest adjustable - Double ball mounting system



Available only with backrest Physio
Not available for backrest Physio AIR carbon shell

- Large (34x14)
- Small (28x14)

05648 252,00

Permobil Limited Unit 7, Polaris Centre, 41 Brownfields, Welwyn Garden City, Herts, AL7 1AN United Kingdom - Phone: +44 1484 722888

Date	Order	User	Address
------------	-------------	------------	---------------

Note



customer_support_uk@permobil.com - https://www.permobil.com/en-gb

Wheelchair : Progeo EGO CUSTOM - Rev. 2023.1

Prices - VAT excluded
to be added to the price list

Send this page only if any optional have been chosen	
<input checked="" type="checkbox"/>	standard (supplied if no requests are indicated)
<input type="checkbox"/>	on request (without extra charge)
<input type="checkbox"/>	optional (cost to be added at the basic price)

REFERENCE TABLES

1	Front height		
	With closed frame (95°) max 5" caster With closed frame (90°) max 5" caster With closed frame (85°) max 4" caster		
	FORK	Casters	
		3"	4"
			5"
SPORT 		max 44	max 45
SMALL 		max 46	max 47
MEDIUM 		max 50	max 51
The size of the fork will be defined only by Progeo in accordance with wheelchair final configuration.			

2	Rear height			
	Rear wheels			
	22"	24"	25"	26"
	min 35	min 38	min 39	min 40
	max 43	max 45	max 46	max 48

3	Footplate option	Footplate distance
	Footplate COMPACT, automatic Closure	min 36
IMPORTANT NOTICE! From the footplate to the floor minimum 4cm !! (Minimum Front height = DP + 4cm.) NOTE! Lower footplate distances are possible only after our valuation Calculated with the best configuration and with the footplates positioned on inside.		

4	Rear wheels	
	Model	Features
	22" Ultra-light Progeo - Standard!	(not available in anthracite color)
	24" Ultra-light Progeo - Standard!	(available for all colors)
	24" ULTRA-LIGHT PROGEO KEY SPORT	(silver hub, black rim and 16 spokes)
	24" Ultra-light "Spinergy LX"	(silver hub, black rim and spokes)
	24" Ultra-light "Spinergy LXL"	(black hub and rim, 18 white spokes) - (black hub, rim and 18 spokes)
	24" Off-road	(colour: black) - (aluminium handrim - tyre Off-road)
	24" Ultra-light "Spinergy Flex rim"	(silver hub, black rim and spokes) - (integrated aluminium/rubber handrim - encumbrance reduction up to 3cm. - all tyre)
	25" Ultra-light "Spinergy LX"	(silver hub, black rim and spokes)
	25" Ultra-light "Spinergy LXL"	(black hub and rim, 18 white spokes)
	26" Progeo - Standard!	(colour: black)
	26" Ultra-light "Spinergy LX"	(silver hub, black rim and 18 spokes)