

Date	Order	User	Address
------------	-------------	------------	---------------



Seat

- ☆ Seat cloth with pocket (under seat)
- Seat with tension straps 08883 **224,00**
- Carbon rigid seat 08336 **475,00**
- Pocket (under seat) [25x11x4,5] 08281 **74,00**

Backrest adjustment and fixing system



- ☆ Backrest with double locking (upright and folded) with rake adjustable from -4° to +16°
- Backrest with upright locking system ONLY (no locking when folded) with rake adjustable from -4° to +16°
- Fixed back(non-folding back) with rake adjustable from -4° to +16°

Backrest



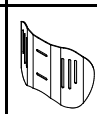

- ☆ Adjustable velcro straps and padded transpiring upholstery
 - ☆ Aluminium backrest  06811 **189,00**
 - Titanium backrest  04389 **749,00**
 - Carbon fibre backrest  04389 **749,00**

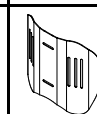
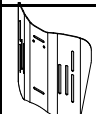
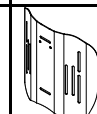
AIR **Integrated posture backrest (NOT REMOVABLE)** **1.047,00**

Carbon shell - Lateral retaining 7,5cm
Depth adjustment ±1cm. - Angle adjustment ±10°
not available for seat width 48

H 28		H 34		H 40	
Backrest Height (TS) min 34		Backrest Height (TS) min 38		Backrest Height (TS) min 44	
(.....)		(.....)		(.....)	
Lateral retaining wing A=high - R=regular					
A	R	A	R	A	R
					
<input type="checkbox"/>	<input type="checkbox"/>	<input type="checkbox"/>	<input type="checkbox"/>	<input type="checkbox"/>	<input type="checkbox"/>

Installation on:

- ☆ Backrest tubes 
- Aluminium backrest 
- Titanium backrest  06811 **189,00**
- Carbon fibre backrest  04389 **749,00**

Handle tube

- ☆ Tubes with short handle
- SPORT tubes Without push handles
- Carbon fibre tubes with short handle (Lightest configuration) 04390 **148,00**
Not available with: Posture backrest PHYSIO - Posture backrest A I R
- Folding handles  02958 **252,00**

Colour set: Rear wheels and forks - To be matched only with: Rear wheels Ultra-light Progeo - Standard! (22 - 24)

- ☆ Black 22" 24" 25" 26"
- Bright silver 22" 24" 00833 **126,00**
- Bright orange 22" 24" 00833 **126,00**
- Bright anthracite 24" 00833 **126,00**
- Bright fuchsia 22" 24" 00833 **126,00**
- Bright blue 22" 24" 00833 **126,00**
- Bright red 22" 24" 00833 **126,00**
- Bright lime 22" 24" 00833 **126,00**
- Pearl white 22" 24" 00833 **126,00**

Casters

- ☆ 4" Soft
- 3" Sport (Lightest configuration)
- 5" Soft Not available with frame angle 90° to the floor
- 3" Active Soft (wide) - Aluminium alloy rim 06824 **126,00**
- 4" Active Sport (narrow) - Aluminium alloy rim 01398 **126,00**
- 4" Active Soft (wide) - Aluminium alloy rim 03943 **126,00**
- 5" Active Soft (wide) - Aluminium alloy rim Not available with frame angle 90° to the floor 07518 **126,00**
- 5" Pneumatic Not available with frame angle 90° to the floor 10844 **63,00**

Permobil Limited Unit 7, Polaris Centre, 41 Brownfields, Welwyn Garden City, Herts, AL7 1AN United Kingdom - Phone: +44 1484 722888





customer_support_uk@permobil.com - https://www.permobil.com/en-gb

Date	Order	User	Address
------------	-------------	------------	---------------

Rear wheels			
<input checked="" type="checkbox"/> 24" Ultra-light Progeo - Standard!			
<input type="checkbox"/> 22" Ultra-light Progeo - Standard!			
<input type="checkbox"/> 25" Ultra-light Progeo - Standard!		(colour: black)	
<input type="checkbox"/> 26" Progeo - Standard!		(colour: black)	
<input type="checkbox"/> 24" ULTRA-LIGHT PROGEO KEY SPORT		(Lightest configuration)	04383 876,00
<input type="checkbox"/> 24" Ultra-light "Spinergy LX"			01685 876,00
<input type="checkbox"/> 24" Ultra-light "Spinergy LXL"	<input type="checkbox"/> Black hub and white spokes	<input type="checkbox"/> Hub and spokes black	07846 876,00
<input type="checkbox"/> 24" Ultra-light "Spinergy Flex rim"	Integrated aluminium/rubber handrim		02270 1.374,00
<input type="checkbox"/> 25" Ultra-light "Spinergy LX"			02101 876,00
<input type="checkbox"/> 25" Ultra-light "Spinergy LXL"	<input type="checkbox"/> Black hub and white spokes		07847 876,00
<input type="checkbox"/> 26" Ultra-light "Spinergy LX"			02102 876,00
<input type="checkbox"/> 24" Off-road (aluminium handrim black)			01392 224,00

Rear wheel tyre			
<input checked="" type="checkbox"/> High pressure tyre	(22"-24"-25"-26")	(Lightest configuration)	
<input type="checkbox"/> High pressure profile tyre	(24")		
<input type="checkbox"/> Marathon Plus	(24"-25")	with anti-puncture protection	01669 63,00
<input type="checkbox"/> Anti-puncture - Colour Grey	(22")		04181 98,00
<input type="checkbox"/> Anti-puncture - Colour Black	(24")		11083 126,00

Handrim	Wheel distance <input checked="" type="checkbox"/> 3 cm	<input type="checkbox"/> 4 cm		
<input checked="" type="checkbox"/> Aluminium	(22"-24"-25"-26")	(Lightest configuration)		
<input type="checkbox"/> Aluminium black SOFT-TOUCH	(24"-25")	(24" handrim, on 25" wheel is installed with spacers)	09170	126,00
<input type="checkbox"/> Chromed Steel	(24"-25")	(24" handrim, on 25" wheel is installed with spacers)	01684	148,00
<input type="checkbox"/> Titanium	(24"-25")	(24" handrim, on 25" wheel is installed with spacers)	00016	275,00
<input type="checkbox"/> Ultra Grepp	(24"-25")	(24" handrim, on 25" wheel is installed with spacers)	00017	315,00
<input type="checkbox"/> Max Grepp	(24"-25")	(24" handrim, on 25" wheel is installed with spacers)	00834	349,00
<input type="checkbox"/> Ergo Para	(24")		00632	349,00
<input type="checkbox"/> TOP FRICTION	(24"-25")	(24" handrim, on 25" wheel is installed with spacers)	11023	399,00
<input type="checkbox"/> Oval countour with a rubber insert				
<input type="checkbox"/> NOVA H	(24"-25")	(24" handrim, on 25" wheel is installed with spacers)	11025	263,00
<input type="checkbox"/> Ergonomic black profile				
<input type="checkbox"/> NOVA D	(24"-25")	(24" handrim, on 25" wheel is installed with spacers)	11026	286,00
<input type="checkbox"/> Ergonomic profile with rubber coating (ideal for quadriplegics)				
<input type="checkbox"/> SURGE LT	(25")	Oval countour with a rubber insert	06427	360,00
<input type="checkbox"/> Quad	(24")		00693	200,00
<input type="checkbox"/> Silicon cover for standard aluminium handrim		Available for measures (22" - 24" - 26")	04050	160,00



Wheel locks			
<input checked="" type="checkbox"/> Bent lever push to lock			
<input type="checkbox"/> Straight lever push to lock			
<input type="checkbox"/> Straight lever pull to lock			
<input type="checkbox"/> Sport brake		(Lightest configuration)	06428 126,00
<input type="checkbox"/> Brake with extension lever push to lock			01949 63,00
<input type="checkbox"/> Brake with extension lever pull to lock			03372 63,00



Mudguard			
<input checked="" type="checkbox"/> Carbon fibre mudguard			
<input type="checkbox"/> Carbon fibre Straight sideguard	<input checked="" type="checkbox"/> Aligned wheel	<input type="checkbox"/> Under wheel cm	<input type="checkbox"/> Above wheel cm
<input type="checkbox"/> Removable carbon fibre mudguard			04109 252,00
<input type="checkbox"/> Removable Carbon fibre straight sideguard	<input checked="" type="checkbox"/> Aligned wheel	<input type="checkbox"/> Under wheel cm	<input type="checkbox"/> Above wheel cm
<input type="checkbox"/> Welded straight mudguard	Available only with made-to-measure welded frame and fixed and welded backrest		08933 372,00
	<input checked="" type="checkbox"/> Aligned wheel	<input type="checkbox"/> Under wheel cm	<input type="checkbox"/> Above wheel cm

Date	Order	User	Address
------------	-------------	------------	---------------

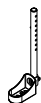
Armrests			
<input type="radio"/> Tubular armrests	(Swing away, removable and height adjustable armrest)		00694 252,00

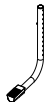
Accessories			
<input type="radio"/> Pad for front frame protectors			07058 52,00
<input type="radio"/> Backrest-seat connection cloth			10241 17,00
<input type="radio"/> Removable storage bag (with quick coupling)			09811 126,00

Optional 1			
<input type="checkbox"/> Set-up for post-sale optional assembly			
<input type="radio"/> Transit wheels			03290 148,00
<input type="radio"/> Crutches support	<input type="radio"/> Right <input type="radio"/> Left		00838 74,00 00837 74,00
<input type="radio"/> Anti-tipper with rapid hookup	(inside rotation to reduce the encumbrance) <input type="radio"/> Right <input type="radio"/> Left		06821 126,00 06822 126,00
<input type="radio"/> Tipping aid	<input type="radio"/> Right <input type="radio"/> Left		00025 74,00 01046 74,00

Optional 2			
<input type="radio"/> Push handles for companion	(Removable and height adjustable)		03645 177,00
<input type="radio"/> Tetraclip	(Quick release axle for quadriplegic)		03947 177,00
<input type="radio"/> Safety pelvic belt			03972 63,00
<input type="radio"/> Harness			04103 126,00
<input type="radio"/> Lumbar support	(to insert in the backrest upholstery)		00013 40,00
<input type="radio"/> Swing away lateral support	<input type="radio"/> Right <input type="radio"/> Left		02097 252,00 02098 252,00
Not available with: Posture backrest PHYSIO - Posture backrest A I R			
<input type="radio"/> Spoke guards Black	(22"-24")		01043 148,00
<input type="radio"/> Spoke guards Transparent	(22"-24")		00835 148,00
<input type="radio"/> Spoke guards Progeo design	(22"-24")		00019 177,00
<input type="radio"/> Spoke guards Dragon	(22"-24")		02106 177,00

Additional Kit			
<input type="radio"/> 24" Off-road rear wheels	Off-Road tyre - aluminium handrim (black colour)		03378 498,00
<input type="radio"/> 24" FAT rear wheels	FAT tyre 3" - aluminium handrim (black colour)		09357 876,00

Date Order User Address

PHYSIO - Posture backrest
(Std. Backrest upholstery not provided)
 Removable with quick release
 Suitable for tubes with diameter 18+26mm
 Depth adjustment (4cm)
 Angle adjustment ($\pm 18^\circ$)

AIR Carbon shell
 not available for seat width 48

BACKREST HEIGHT	28	34	40	40		
Shell's shape 	Lateral retaining wing A=high - R=regular					
	A	R	A	R	A	R
7,5 cm						
	<input type="checkbox"/>	<input type="checkbox"/>	<input type="checkbox"/>	<input type="checkbox"/>	<input type="checkbox"/>	<input type="checkbox"/>

POSTURE Aluminum shell

BACKREST HEIGHT	34	40	52	1.013,00		
Shell's shape 	Lateral retaining wing B=regular					
	R	R	R			
7,5 cm						
	<input type="checkbox"/>	<input type="checkbox"/>	<input type="checkbox"/>			

Configuration DEEP with side support PAD (height adjustable)

Aluminum lateral with padded, breathable upholstery.



Small (h 13cm)	Large (h 20cm)
<input type="checkbox"/> Right 10272	<input type="checkbox"/> Right 10273
29,00	40,00
<input type="checkbox"/> Left 10272	<input type="checkbox"/> Left 10273
29,00	40,00

SWING AWAY - Lateral support

Fixing and adjustment hardware complete with protection sleeve
 Aluminum lateral with padded, breathable upholstery.

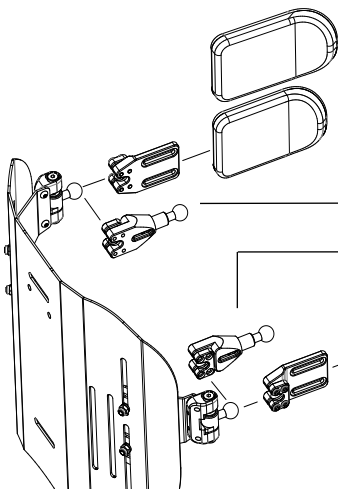

<input type="radio"/> Large (18x12)	05647	183,00
<input type="radio"/> Small (14x9)	05643	183,00
<input type="radio"/> Lateral support extension	Quantity (number pcs).....	
<input type="radio"/> Lateral support extension	10271	69,00
<input type="radio"/> Small (14x9)	05642	183,00
<input type="radio"/> Large (18x12)	05646	183,00

Headrest adjustable - Double ball mounting system

Available only with backrest Physio
 Not available for backrest Physio AIR carbon shell



<input type="checkbox"/> Large (34x14)	05648	252,00
<input type="checkbox"/> Small (28x14)		

Date	Order	User	Address
------------	-------------	------------	---------------

1	A Footplate width			
	DP	35+39	40+45	46+50
LS				
33	21	20	19	
36	24	23	22	
39	26	25	24	
42	29	28	27	
45	32	31	30	
48	35	34	33	

2	Setting	C :
	Extremely prudential	7,5
	Prudential	9
	Standard	10,5
	Active	12
	Extreme	13,5

3	Lt
Camber	Maximum width
0°	LS + 18
2°	LS + 21
4°	LS + 24
8°	LS + 30
12°	LS + 36

Maximum width calculated including 3 cm. distance between tyre and handrim

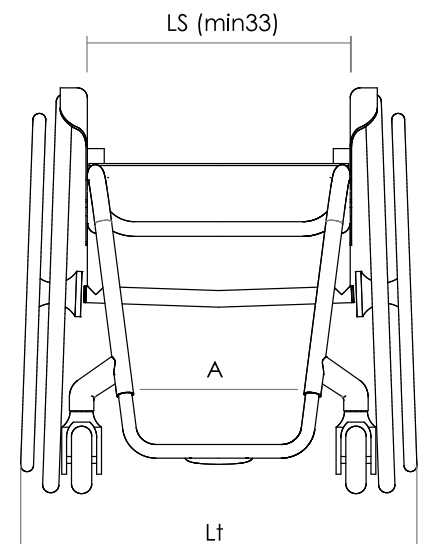
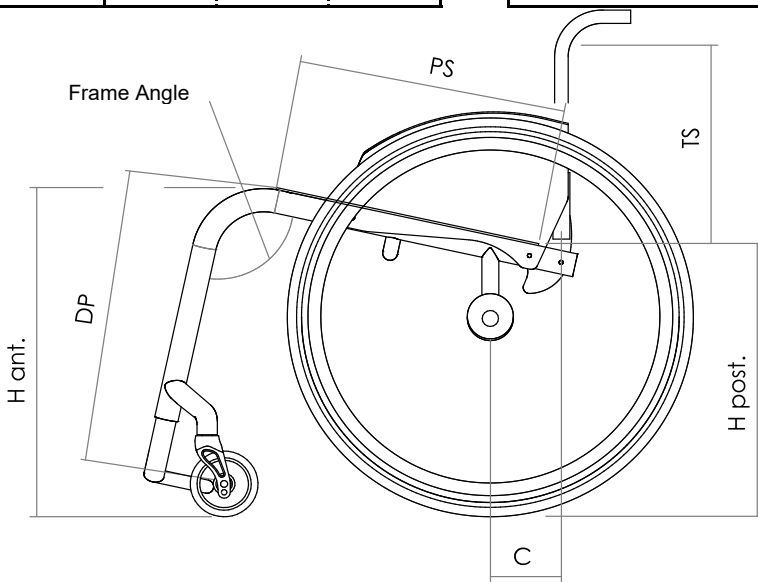

Wheelchair : Progeo JOKER ENERGY - Rev. 2023.1

Prices - VAT excluded
to be added to the price list

Send this page only if any optional have been chosen		
<input type="checkbox"/>	standard	(supplied if no requests are indicated)
<input type="checkbox"/>	on request	(without extra charge)
<input type="checkbox"/>	optional	(cost to be added at the basic price)